

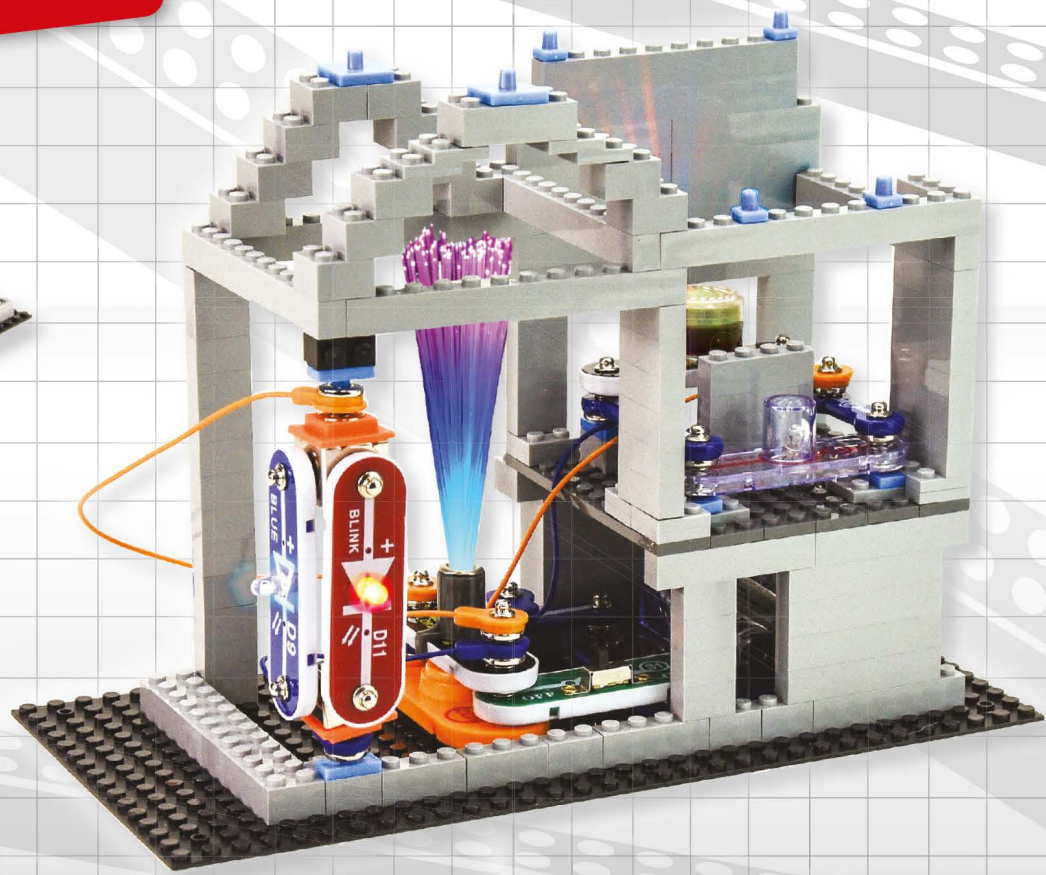

# BOFFIN

# Bric: Structures



# Instruction Manual



# Table of Contents

Basic Troubleshooting	1	Advanced Troubleshooting	7
Parts List	2	Project Listings	7
How to Use Boffin	3	Schematics and Blue Prints	8
About Your Boffin Parts	4	Projects	9-54
Introduction to Electricity	5	Other Boffin Products	55
DOs and DON'Ts of Building Circuits	6		

 **WARNING: SHOCK HAZARD** - Never connect Boffin to the electrical outlets in your home in any way!

 **WARNING: CHOKING HAZARD** - Small parts. Not for children under 3 years.

Conforms to all applicable U.S. government requirements and CAN ICES-3 (B)/NMB-3 (B).

## Basic Troubleshooting

1. Most circuit problems are due to incorrect assembly, always double-check that your circuit exactly matches the drawing for it.
2. Be sure that parts with positive/negative markings are positioned as per the drawing.
3. Be sure that all connections are securely snapped.
4. Try replacing the batteries.

**ConQuest entertainment a.s. is not responsible for parts damaged due to incorrect wiring.**

**Note:** If you suspect you have damaged parts, you can follow the Advanced Troubleshooting procedure on page 7 to determine which ones need replacing.

**WARNING:** Always check your wiring before turning on a circuit. Never leave a circuit unattended while the batteries are installed. Never connect additional batteries or any other power sources to your circuits. Discard any cracked or broken parts.

**Adult Supervision:**  
Because children's abilities vary so much, even with age groups, adults should exercise discretion as to which experiments are suitable and safe (the instructions should enable supervising adults to establish the experiment's suitability for the child). Make sure your child reads and follows all of the relevant instructions and safety procedures, and keeps them at hand for reference.

This product is intended for use by adults and children who have attained sufficient maturity to read and follow directions and warnings.

Never modify your parts, as doing so may disable important safety features in them, and could put your child at risk of injury.

 **Batteries:**

- Use only 1.5V AA type, alkaline batteries (not included).
- Insert batteries with correct polarity.
- Non-rechargeable batteries should not be recharged. Rechargeable batteries should only be charged under adult supervision, and should not be recharged while in the product.
- Do not connect batteries or battery holders in parallel.
- Do not mix old and new batteries.
- Do not mix alkaline, standard (carbon-zinc), or rechargeable (nickel-cadmium) batteries.
- Remove batteries when they are used up.
- Do not short circuit the battery terminals.
- Never throw batteries in a fire or attempt to open its outer casing.
- Batteries are harmful if swallowed, so keep away from small children.

## Parts List (Colors and styles may vary) Symbols and Numbers

**Important:** If any parts are missing or damaged, **DO NOT RETURN TO RETAILER.** Call toll-free +420 284 000 111 or e-mail us at: info@cqe.cz.  
Customer Service: ConQuest entertainment a. s., Kolbenova 961, 198 00, Praha 9, www.boffin.cz

Qty.	ID	Name	Symbol	Part #	Qty.	ID	Name	Symbol	Part #
4		Brick 1x1, 3-Sided		6BR1X1S3	1		Brick Remover Tool		6BRTOOL
33		Brick 1x2		6BR1X2G	3	(3)	3-Snap Wire		6SC03
10		Brick 1x3		6BR1X3G	2		3D Snap		6SC3DSNAP
11		Brick 1x4		6BR1X4G	1	(B3)	Battery Holder - uses three (3) 1.5V type "AA" (not Included)		6SCB3
11		Brick 1x6		6BR1X6G	1	(D8)	Color LED		6SCD8
4		Brick 1x10		6BR1X10G	1	(D9)	Blue LED		6SCD9
7		Brick 1x12		6BR1X12G	1	(D11)	Blink Red LED		6SCD11
18		Brick 2x2		6BR2X2G	1	(D12)	Color2 LED		6SCD12
6		Brick 2x4		6BR2X4G	1		Fiber Optic Tree		6SCFT
8		Brick 2x6		6BR2X6G	1		Mounting Base		6SCFMB
25		Bric2snap Adapter, 1x1		6BRA1X1	2		Jumper Wire (Orange)		6SCJ3A
25		Bric2snap Adapter, 1x2		6BRA1X2	3		Jumper Wire (Blue)		6SCJ4
25		Bric2snap Adapter, 2x2		6BRA2X2	1	(L4)	4.5V Lamp		6SCL4
1		Baseplate 10" x 5"		6BRBP1	1		Lined Lens LED Attachment		6SCLENS
6		Plate 2x12		6BRP2X12DG	1	(S1)	Slide Switch		6SCS1
20		Plate 2x2		6BRP2X2G	1	(U32)	Melody IC		6SCU32





# How to Use Boffin

Boffin uses building blocks snaps with to build the different electrical and electronic circuits in the projects. Each block has a function: there are switch blocks, light blocks, battery blocks, different length wire blocks, etc. These blocks are different colors and have numbers and letters on them so that you can easily identify them. The blocks you will be using are shown as color symbols, allowing you to easily snap them together to form a circuit.

### For Example:

This is the slide switch, it is green and has the marking (S1) on it. The part symbols in this booklet may not exactly match the appearance of the actual parts, but will clearly identify them.

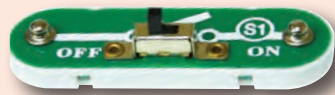

You need a power source to build each circuit. This is labeled (B3) and requires three (3) 1.5V "AA" batteries (not included).



When installing a battery, be sure the spring is compressed straight back, and not bent up, down, or to one side.

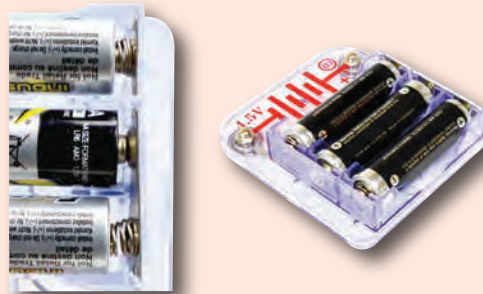

Some circuits use the jumper wires to make unusual connections. Just clip them on as indicated.



Often you will mount Boffin components on bric2snap adapters, simply place them on the posts of the adapters:

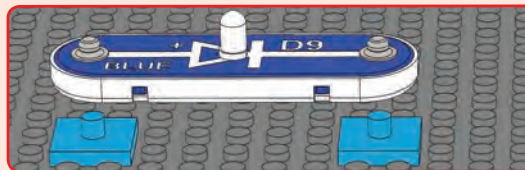

Sometimes it can be difficult to separate bric2snap adapters from the baseplate or bricks and plates, so use the Brick Remover Tool for help for needed, as shown:

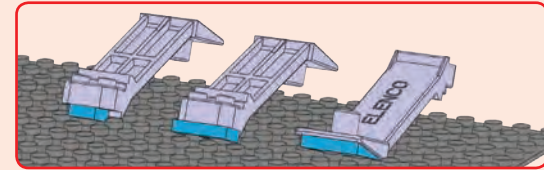
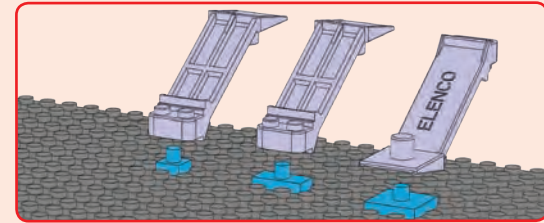

You can also use the remover to separate bricks and plates from each other.

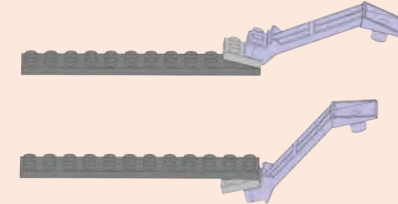

Note that this set includes 25 of each of the bric2snap adapter pieces, more are used in projects in this booklet. Your set includes extra adapters so you can easily expand on your own using other Boffin and bricks sets you may have.

**Note:** While building the projects, be careful not to accidentally make a direct connection across the battery holder (a "short circuit"), as this may damage and/or quickly drain the batteries.





# About Your Boffin Parts

## BATTERY HOLDER

The **batteries (B3)** produce an electrical voltage using a chemical reaction. This “voltage” can be thought of as electrical pressure, pushing electricity through a circuit just like a pump pushes water through pipes. This voltage is much lower and much safer than that used in your house wiring. Using more batteries increases the “pressure”, therefore, more electricity flows.



Battery Holder (B3)

## SLIDE SWITCH

The **slide switch (S1)** connects (“ON”) or disconnects (“OFF”) the wires in a circuit. When ON it has no effect on circuit performance. Switches turn on electricity just like a faucet turns on water from a pipe.

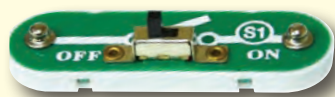

*(Part designs are subject to change without notice).*

## SNAP WIRES & JUMPER WIRES



The blue **3-snap wires** and **jumper wires** (blue & orange) are wires used to connect components. They are used to transport electricity and do not affect circuit performance. The 3-snap wires make rigid connections, while the jumper wires make flexible connections.

Wires transport electricity just like pipes are used to transport water. The colorful plastic coating protects them and prevents electricity from getting in or out.

## SOUND MODULE

The **melody IC (U32)** contains a specialized sound-generation integrated circuit (IC), a small speaker, and a few supporting components. The IC has a recording of the melody, which it makes into an electrical signal for the speaker. The speaker converts the signal into mechanical vibrations. The vibrations create variations in air pressure, which travel across the room. You “hear” sound when your ears feel these air pressure variations.



## LEDs

The **color, blue, blink red, and color2 LEDs (D8, D9, D11 & D12)** are light emitting diodes, and may be thought of as a special one-way light bulbs. In the “forward” direction, (indicated by the “arrow” in the symbol) electricity flows if the voltage exceeds a turn-on threshold brightness then increases. The blink red LED contains a microcircuit that turns it on and off. The color and color2 LEDs contain red, green, and blue LEDs, with a micro-circuit controlling them. A high current will burn out an LED, so the current must be limited by other components in the circuit (Boffin LEDs have internal resistors added, to protect them in case you make wiring mistakes). LEDs block electricity in the “reverse” direction.



## LAMP

A light bulb, such as in the **4.5V lamp (L4)**, contains a special thin high-resistance wire. When a lot of electricity flows through, this wire gets so hot it glows bright. Voltages above the bulb’s rating can burn out the wire.



# Introduction to Electricity

What is electricity? Nobody really knows. We only know how to produce it, understand its properties, and how to control it. Electricity is the movement of sub-atomic charged particles (called **electrons**) through a material due to electrical pressure across the material, such as from a battery.

Power sources, such as batteries, push electricity through a circuit, like a pump pushes water through pipes. Wires carry electricity, like pipes carry water. Devices like LEDs, motors, and speakers use the energy in electricity to do things. Switches and transistors control the flow of electricity like valves and faucets control water. Resistors limit the flow of electricity.

The electrical pressure exerted by a battery or other power source is called **voltage** and is measured in **volts (V)**. Notice the “+” and “-” signs on the battery; these indicate which direction the battery will “pump” the electricity.

The **electric current** is a measure of how fast electricity is flowing in a wire, just as the water current describes how fast water is flowing in a pipe. It is expressed in **amperes (A)** or **milliamps (mA)**, 1/1000 of an ampere).

The “**power**” of electricity is a measure of how fast energy is moving through a wire. It is a combination of the voltage and current (Power = Voltage x Current). It is expressed in **watts (W)**.

The **resistance** of a component or circuit represents how much it resists the electrical pressure (voltage) and limits the flow of electric current. The relationship is Voltage = Current x Resistance. When the resistance increases, less current flows. Resistance is measured in **ohms ( $\Omega$ )**, or **kilo ohms (k $\Omega$ )**, 1000 ohms).

Nearly all of the electricity used in our world is produced at enormous generators driven by steam or water pressure. Wires are used to efficiently transport this energy to homes and businesses where it is used. Motors convert the electricity back into mechanical form to drive

machinery and appliances. The most important aspect of electricity in our society is that it allows energy to be easily transported over distances.

Note that “distances” includes not just large distances but also tiny distances. Try to imagine a plumbing structure of the same complexity as the circuitry inside a portable radio - it would have to be large because we can't make water pipes so small. Electricity allows complex designs to be made very small.

There are two ways of arranging parts in a circuit, in series or in parallel. Here are examples:

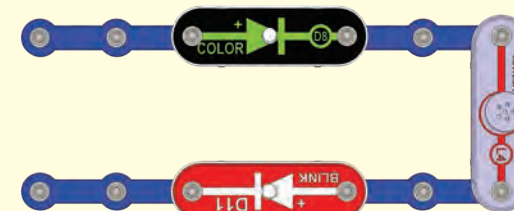

Series Circuit

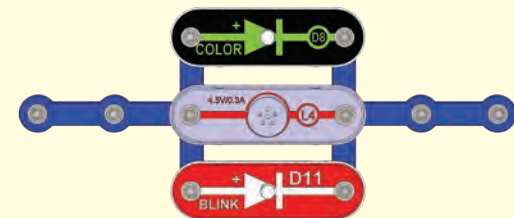

Parallel Circuit

Placing components in series increases the resistance; highest value dominates. Placing components in parallel decreases the resistance; lowest value dominates.

The parts within these series and parallel sub-circuits may be arranged in different ways without changing what the circuit does. Large circuits are made of combinations of smaller series and parallel circuits.

# DOs and DON'Ts of Building Circuits

After building the circuits given in this booklet, you may wish to experiment on your own. Use the projects in this booklet as a guide, as many important design concepts are introduced throughout them. Every circuit will include a power source (the batteries), a resistance (which might be a lamp, melody IC, or LED (which has an internal protection resistor), etc.), and wiring paths between them and back. **You must be careful not to create "short circuits" (very low-resistance paths across the batteries, see examples below) as this will damage components and/or quickly drain your batteries.** ConQuest entertainment a.s. is not responsible for parts damaged due to incorrect wiring. If you are only using the parts in this set, then your parts cannot be damaged by incorrect wiring.

## Here are some important guidelines:

**ALWAYS** USE EYE PROTECTION WHEN EXPERIMENTING ON YOUR OWN.

**ALWAYS** include at least one component that will limit the current through a circuit, such as a lamp, melody IC, or an LED (which has an internal protection resistor).

**ALWAYS** use switches in conjunction with other components that will limit the current through them. Failure to do so will create a short circuit and/or damage those parts.

**ALWAYS** disconnect your batteries immediately and check your wiring if something appears to be getting hot.

**ALWAYS** check your wiring before turning on a circuit.

**NEVER** connect to an electrical outlet in your home in any way.

**NEVER** leave a circuit unattended when it is turned on.

For all of the projects given in this book, the parts may be arranged in different ways without changing the circuit. For example, the order of parts connected in series or in parallel does not matter — what matters is how combinations of these sub-circuits are arranged together.

Note that this set includes 25 of each of the bric2snap adapter pieces, though no more than 10 are used in projects in this booklet. Your set includes extra adapters so you can easily expand on your own using other Boffin and bricks sets you may have.

## Examples of SHORT CIRCUITS - NEVER DO THESE!!!

Placing a 3-snap wire directly across the batteries is a SHORT CIRCUIT.

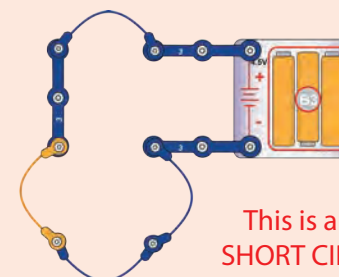
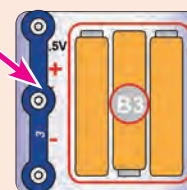

This is also a SHORT CIRCUIT.

When the slide switch (S1) is turned on, this large circuit has a SHORT CIRCUIT path (as shown by the arrows). The short circuit prevents any other portions of the circuit from ever working.

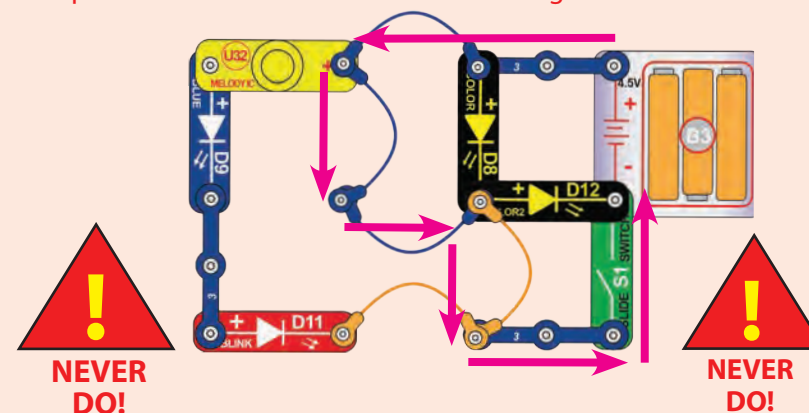

**Warning to Boffin owners:** Do not connect additional voltage sources from other sets, or you may damage your parts. Contact ConQuest entertainment a.s. if you have questions or need guidance.

You are encouraged to tell us about new programs and circuits you create. If they are unique, we will post them with your name and state on our website at: [www.toy.cz](http://www.toy.cz). Send your suggestions to ConQuest entertainment: [info@toy.cz](mailto:info@toy.cz).

**WARNING: SHOCK HAZARD** - Never connect Boffin to the electrical outlets in your home in any way!



# Advanced Troubleshooting (Adult supervision recommended)

ConQuest entertainment a.s. is not responsible for parts damaged due to incorrect wiring.

**If you suspect you have damaged parts, you can follow this procedure to systematically determine which ones need replacing:**

- Lamp (L4), color LED (D8), blue LED (D9), blink red LED (D11), color2 LED (D12), melody IC (U32), and battery holder (B3):** Place batteries in holder. Place the lamp directly across the battery holder, it should light. Place the LEDs (D8, D9, D11, & D12) directly across the battery holder one at a time (LED + to battery +), the LED should light (D8 should change colors, D11 should be blinking, and D12 should slowly change colors). Place the melody IC directly across the battery holder (+ to +), it should play a tune. If none work, then replace your batteries and repeat, if still bad then the battery holder is damaged.
- Jumper wires (blue and orange):** Use this mini-circuit to test each jumper wire, the lamp should light.

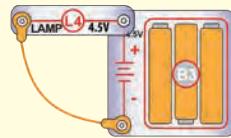

- 3-snap wires:** Use this mini-circuit to test each of the 3-snap wires. The lamp should light.

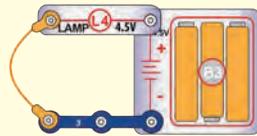

- Slide switch (S1):** Build this mini-circuit; if the lamp doesn't light then the slide switch is bad.

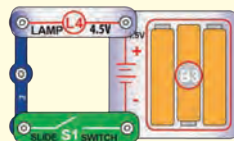

**You may order additional / replacement parts at: [www.toy.cz](http://www.toy.cz)**

ConQuest entertainment a.s., +420 284 000 111, [info@cqe.cz](mailto:info@cqe.cz)

## Project Listings

Project	Description	Page
1	Start Circuit	9-10
2	5 Lights and a Melody	11
3	4 Lights and Clicking	12
4	Light Post	13-14
5	Directional Lights	15
6	Cross of Lights	16-17
7	Bric Tower	18-21
8	Bric Bridge	22-24
9	House of Lights	25-26
10	Bric Mammal	27-28
11	Leds in Series & Parallel	29
12	Bric Building	30-31
13	Tri-Level House	32-34
14	Elevated Circuit	35
15	Bi-Level Circuit	36
16	Overhead Light	37-38
17	3 Shine Out	39-40
18	Light House	41-42
19	Four Fun	43
20	Four Further Fun	44
21	Bric Elevation	45-46
22	Bric House	47-49
23	Diagonal Circuit	50
24	Wall of Lights	51
25	Your Wall of Lights	52
26	2 Story House	53-55

# SCHEMATICS AND BLUE PRINTS

After building the structures in this set, you may want to expand using parts from other brick construction and Boffin sets you already have. For this, advance planning is recommended. Think about what you want your structure to do and how you want it to look before you start building it. Electrical engineers make drawings of their circuits (called schematics), and architects make drawings for their building (called prints or floor plans). Schematics and prints are also useful in analyzing problems or making changes after the circuit or structure has been built.

Electrical schematics use simple symbols to represent the electrical components, often the same symbols that are marked on your Boffin components. Wires are represented by just lines and can be of any length. This is a schematic for the circuit in project 11:

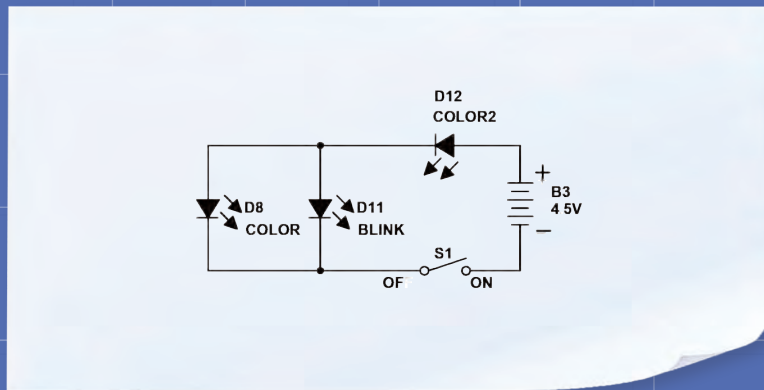

This is a schematic for the circuit in projects 2, 7, 8, 12, 13, and TBD; although those circuits are all constructed differently, electrically they are the same, with D8, D9, D11, D12, L4, and U32 all connected in parallel:

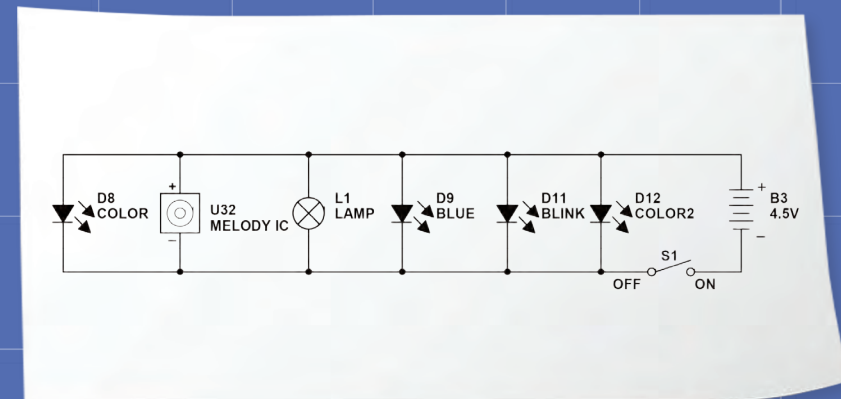

Schematics tell you how a circuit will work, but not how it is constructed. Similarly an architect's print or floor plan of a house tells you about the layout of the house, but not colors or other details. Here is an example of a floor plan drawing for a house:



An architect's drawings may show the floor plan or other information about the construction, depending on who will be using the drawing. These drawings used to be call blueprints, due to the color used when making them years ago. Notice that the symbol for a switch in electrical schematics is based on the architect's symbol for a door.



# Project 1

# START CIRCUIT

1

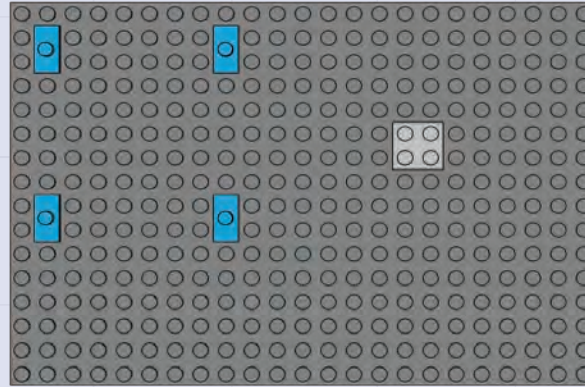

2

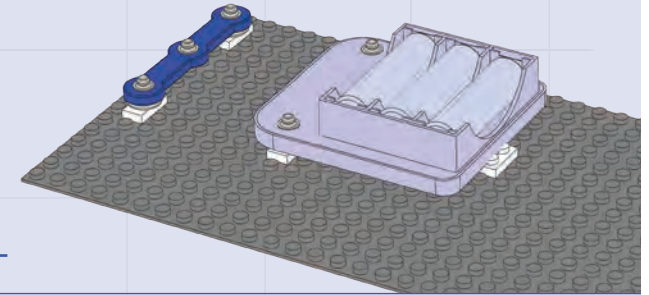
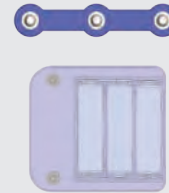

3

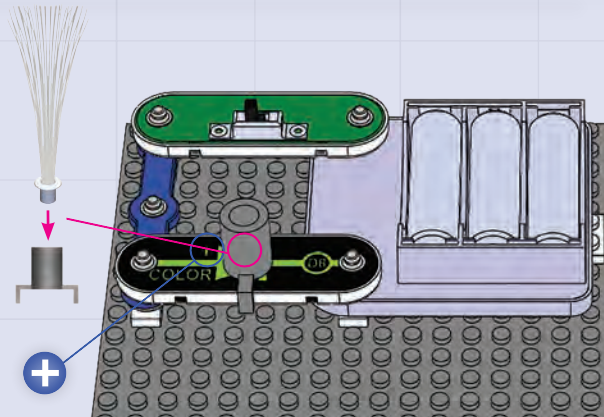

NOTE: this circuit (and many others in this book) have an LED being used without a resistor or other component to limit the electric current through it. Normally this could damage an LED but your Boffin LEDs include internal protection resistors, & will not be damaged. Be careful if you later use other electrical sets with unprotected LEDs. The festive tree and egg may also be used with other Boffin LEDs from different sets.



Boffin uses electronic blocks that snap onto pegs to build different circuits. These blocks have different colors and numbers on them so you can easily identify them.

Place 4 bric2snap adapters and one 2x2 plate on the baseplate as shown. Then mount the 3-snap wire and battery holder (B3) on the adapters. Next, place the slide switch (S1) and color LED (D8) on the other parts, as shown. Install three (3) "AA" batteries (not included) into the battery holder (B3) if you have not done so already; be sure the battery springs are compressed straight back, and not bent up, down, or to one side.





## Project 1

## START CIRCUIT

Turn on the slide switch, and enjoy the light show from the color LED (D8). For best effects, place the fiber optic tree on the color LED using the mounting base, and dim the room lights.

### Variants:

- A. Replace the color LED with the color2 LED (D12). The color2 LED changes colors more slowly.
- B. Replace the color2 LED with the blue LED (D9).
- C. Replace the blue LED (D9) with the blink red LED (D11).
- D. Replace the blink red LED (D11) with the lamp (L4).
- E. Replace the lamp (L4) with the melody IC (U32, "+" on left).

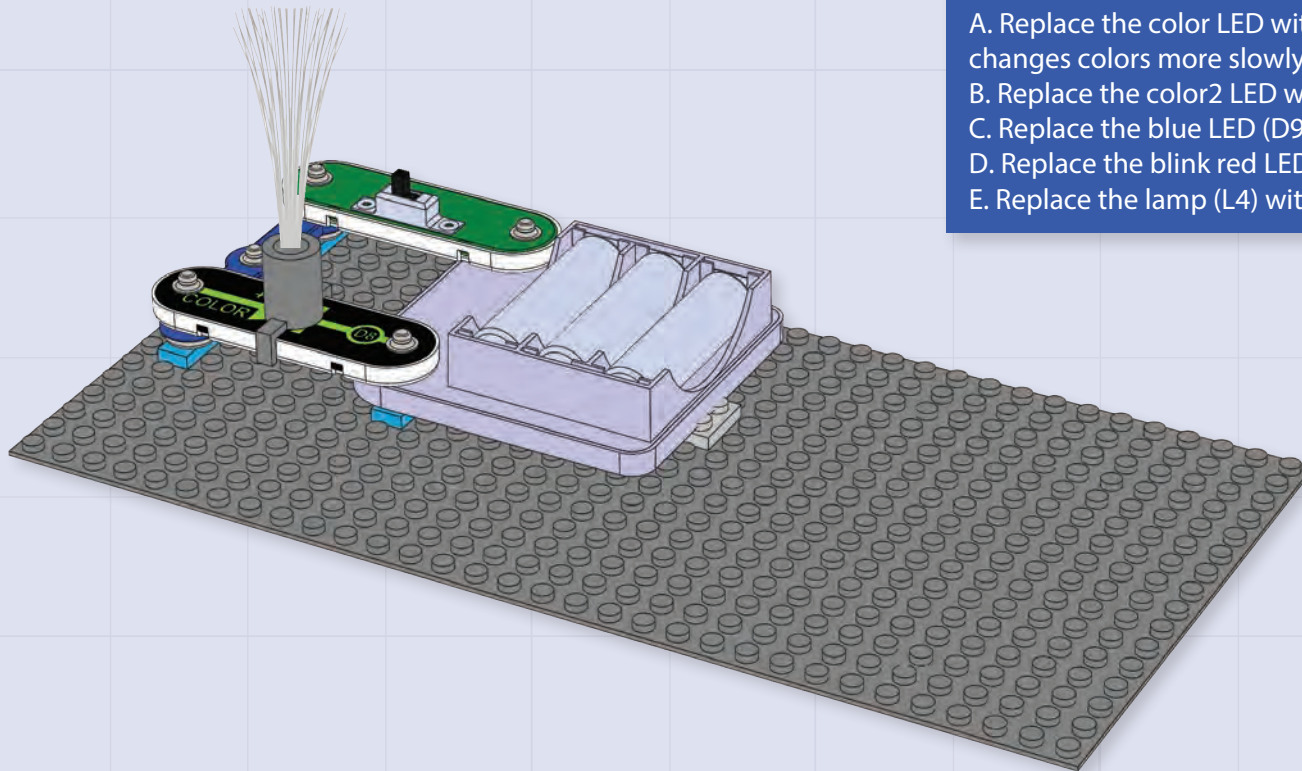

Snappy says when you turn on the slide switch, electricity flows from the batteries, through the color LED and back to the battery through the switch. If the switch is off, the flow of electricity is blocked, and the color LED won't light.

LEDs are light emitting diodes, which convert electrical energy into light. The color of the light depends on the characteristics of the material used in them. The color LED actually contains separate red, green, and blue lights, with a micro-circuit controlling them; the colors can be combined to produce yellow, cyan, purple, and white.



# Project 2

# 5 LIGHTS AND A MELODY

1

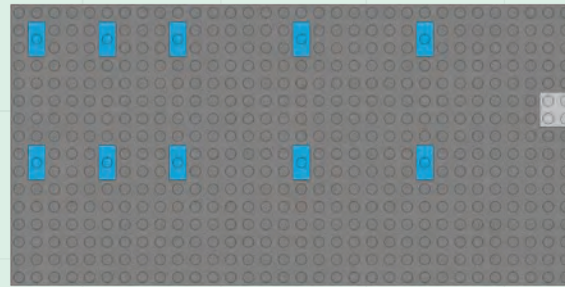
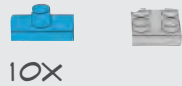

2

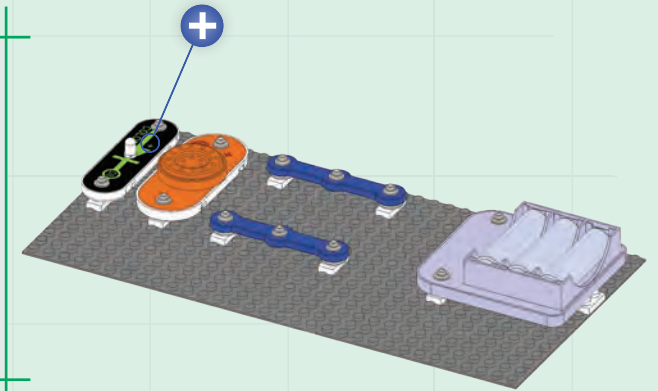
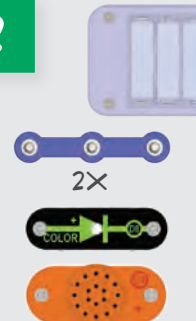

3

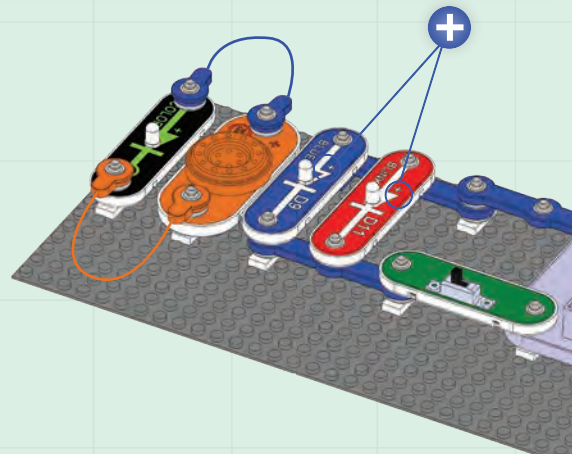
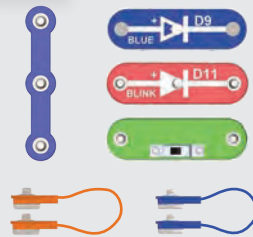

4

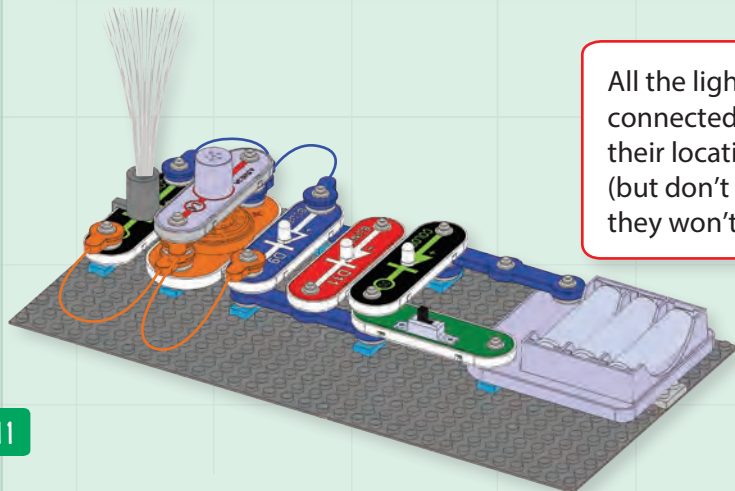
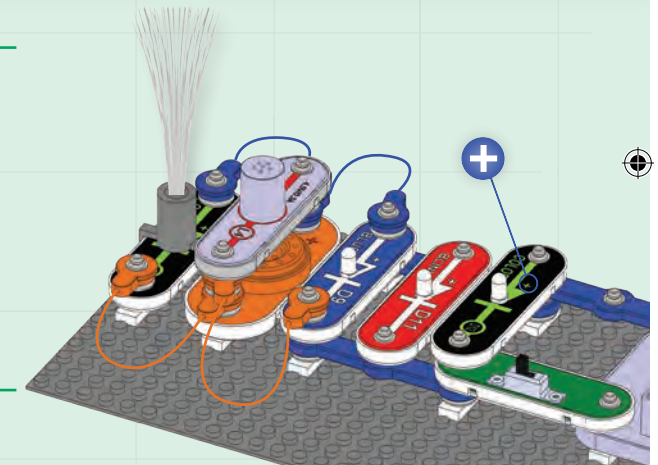

All the lights and the melody IC are connected in parallel, so swapping their locations won't change the circuit (but don't connect them backwards or they won't work).



Build the circuit as shown, and turn on the slide switch (S1). The lamp (L4) and 4 LEDs (D8, D9, D11, & D12) light, and the melody IC (U32) plays. For best effects, place the fiber optic tree on one of the LEDs using the mounting base, and dim the room lights.



# Project 3

# 4 LIGHTS AND CLICKING

1

- 8X
- 7X
- 6X

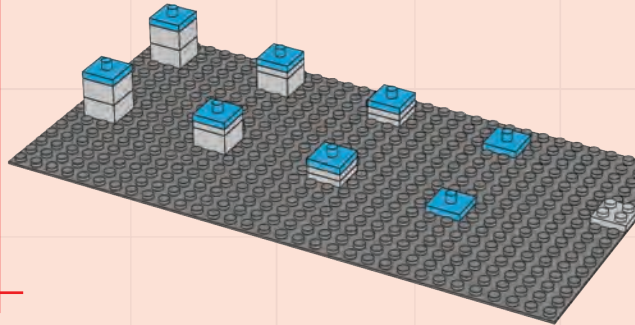

2

- 3X
- 
- 
- 

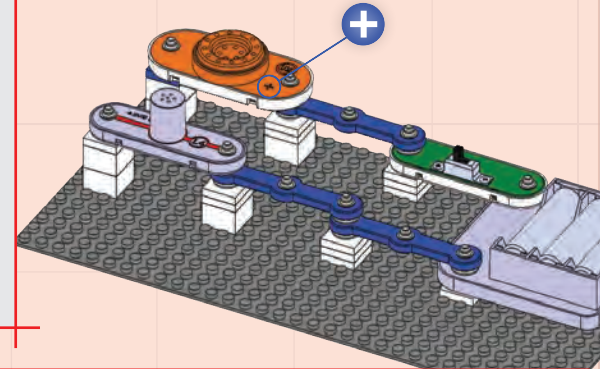

3

- 
- 
- 
- 

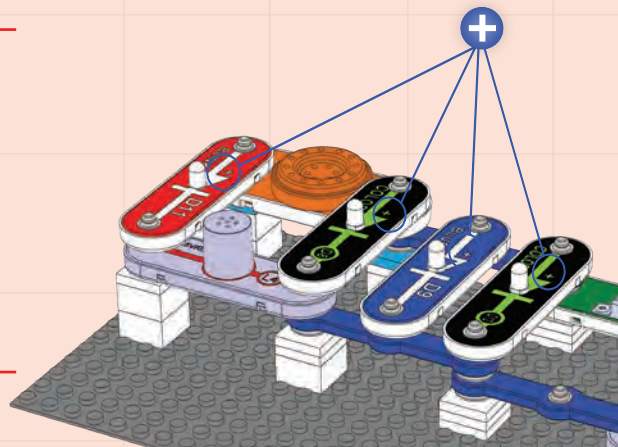

4

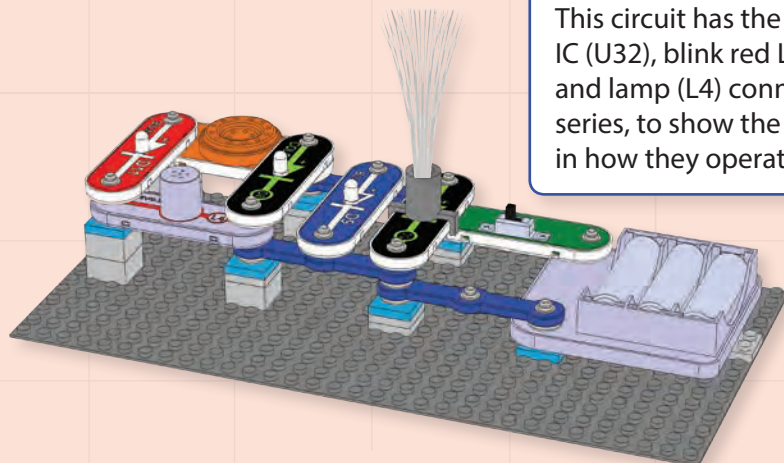
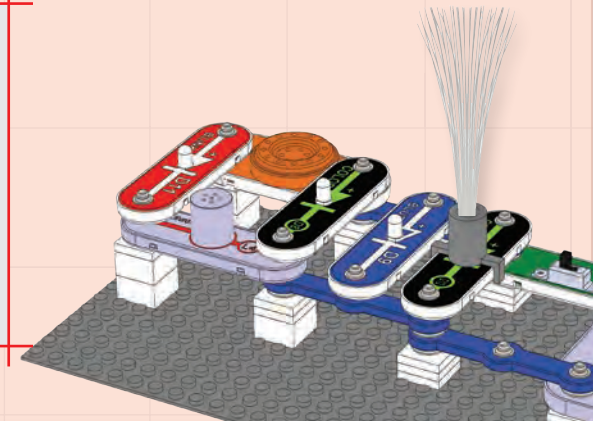

This circuit has the melody IC (U32), blink red LED (D11), and lamp (L4) connected in series, to show the differences in how they operate.



Build the circuit as shown, and turn on the slide switch (S1). The four LEDs (D8, D9, D11, & D12) should be on, the lamp (L4) should be off, and there may be a slight clicking from the melody IC (U32). For best effects, place the fiber optic tree on one of the LEDs using the mounting base, and dim the room lights.

- Next, add a jumper wire at one of these locations:
- A. Across U32: the sound stops and D11 is brighter.
  - B. Across D11: D11 is off, and U32 plays a tune.
  - C. Across U32 and D11: L4 is on.

Use the remover tool to help separate the bricks and adapters when dismantling the circuit.





# Project 4 LIGHT POST

1

- 7X
- 7X
- 4X

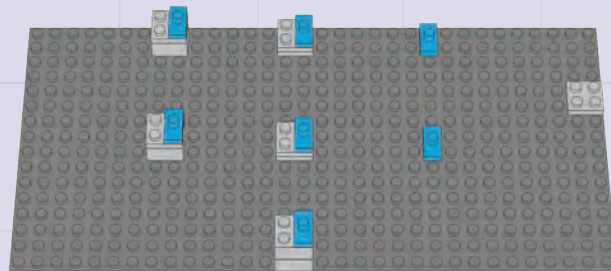

2

- 
- 3X
- 

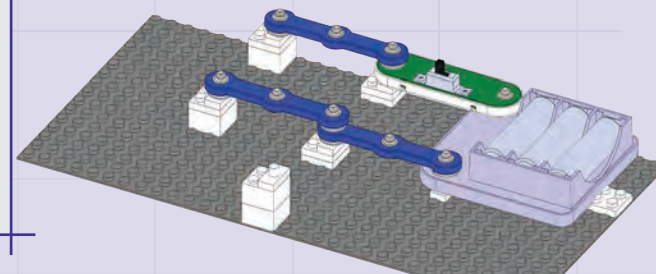

3

- 
- 
- 2X

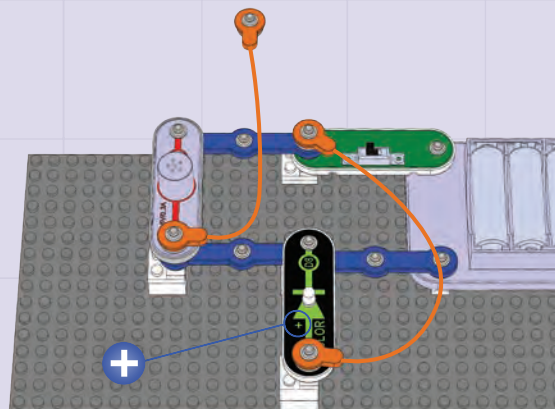

4

- 2X
- 2X
- 9X
- 6X
- 2X
- 2X

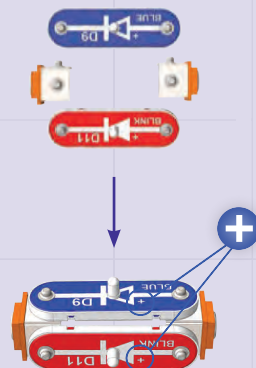
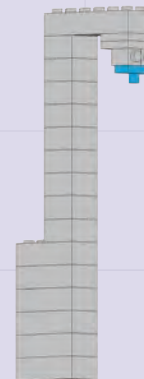

5

- 
- 
- 

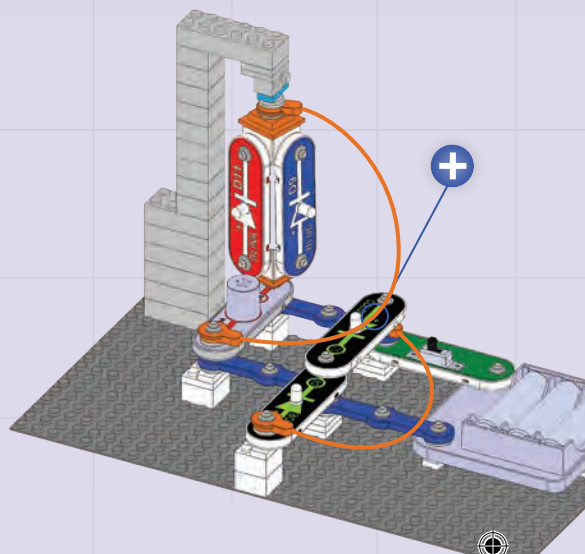

6

- 
- 
- 

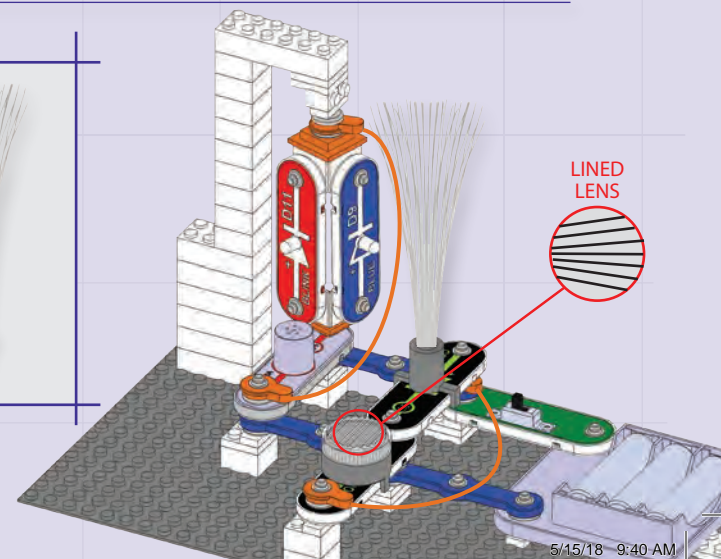

LINED LENS



## Project 4

## LIGHT POST

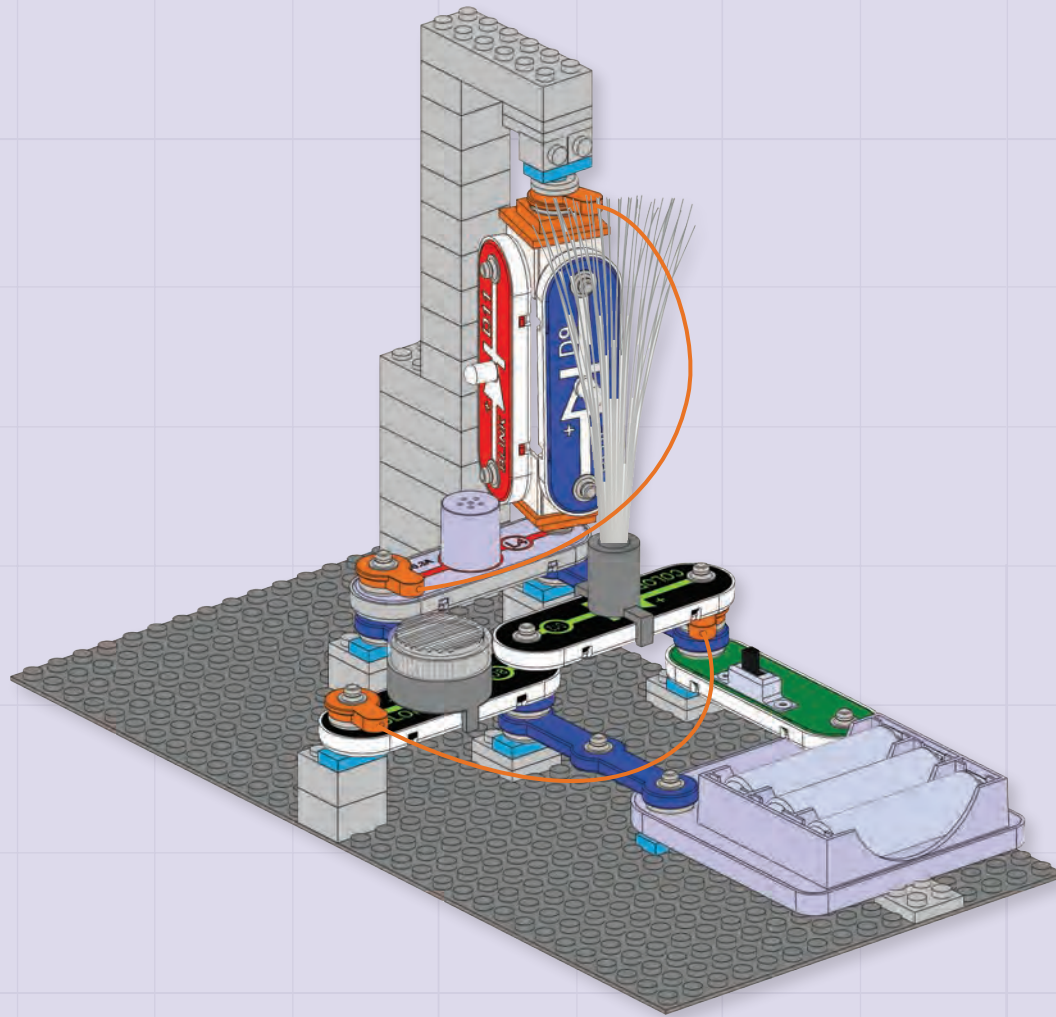

Build the circuit as shown, and turn on the slide switch (S1). The four LEDs (D8, D9, D11, & D12) and lamp (L4) light. The 3D snaps allow the blue and blink red LEDs to be rotated to shine in any direction. For best effects, place the fiber optic tree on the color2 LED (D12) using the mounting base, place the lined lens on the color LED (D8), and dim the room lights. You can swap LED locations as desired.







# Project 5

# DIRECTIONAL LIGHTS

Build the circuit as shown, and turn on the slide switch (S1). The LEDs (D9 & D11) light, and can be rotated to shine in any direction.

You can replace the LEDs with any of the other ones.

1

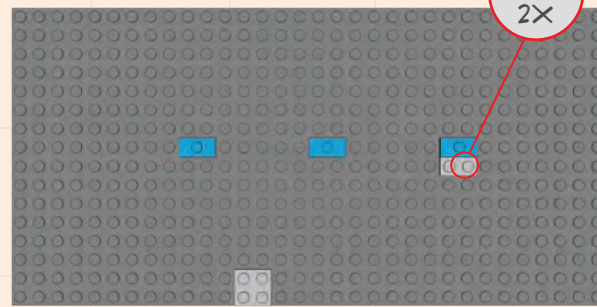
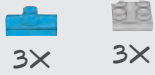

2

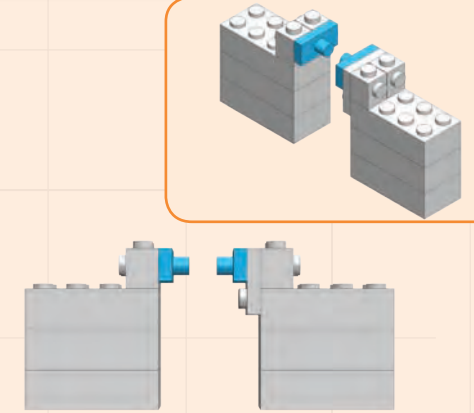
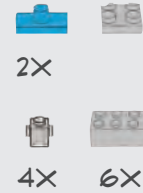

3

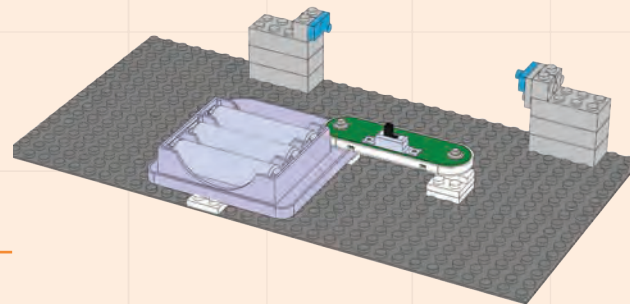
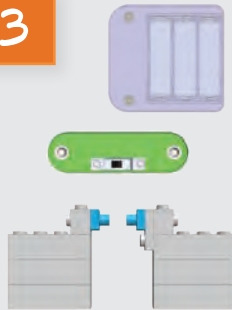

4

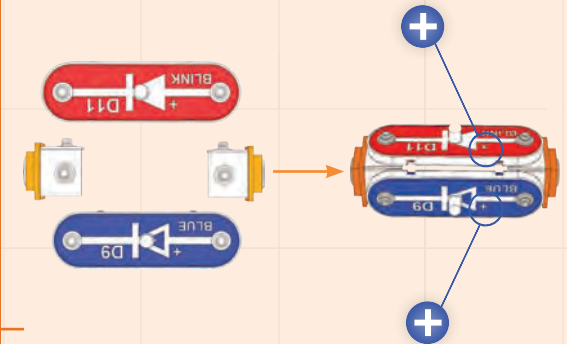
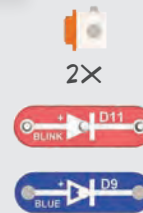

5

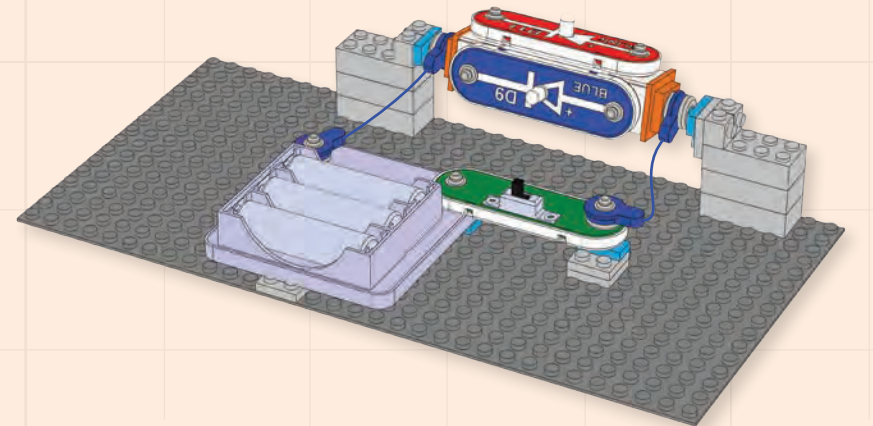
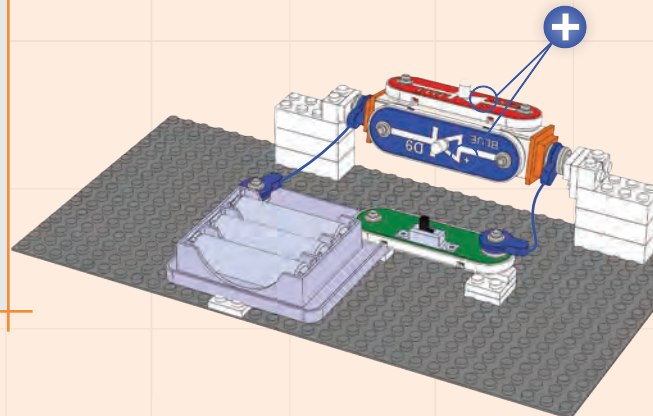



# Project 6

# CROSS OF LIGHTS

1

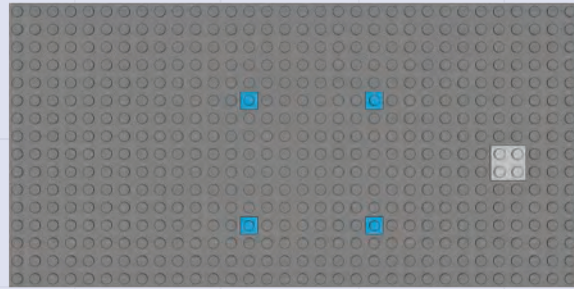
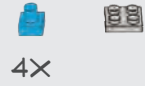

2

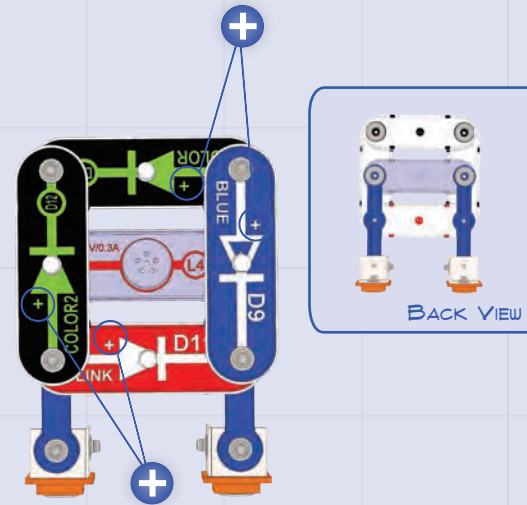
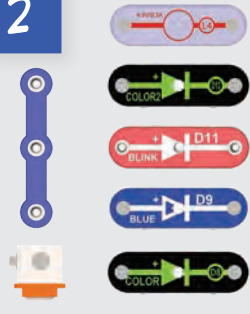

3

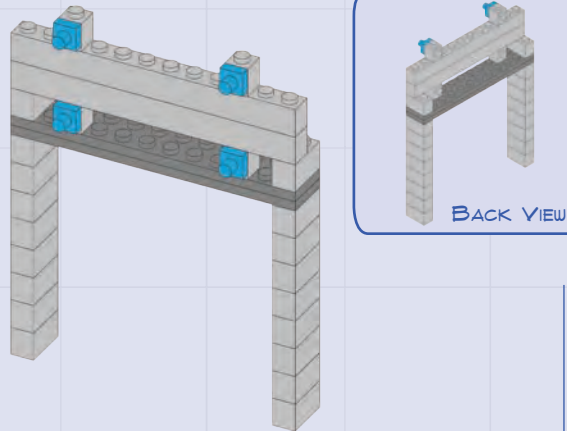
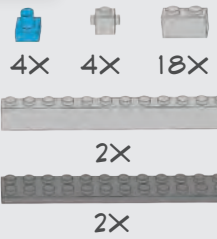

4

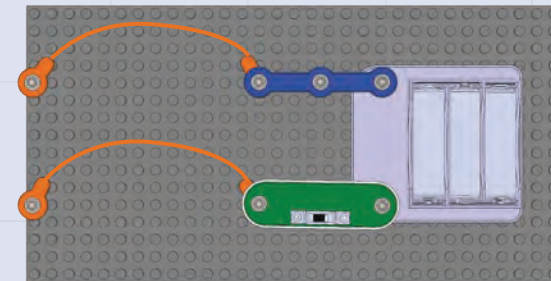
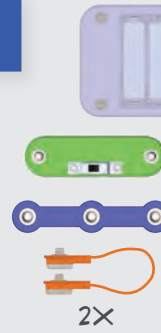

5

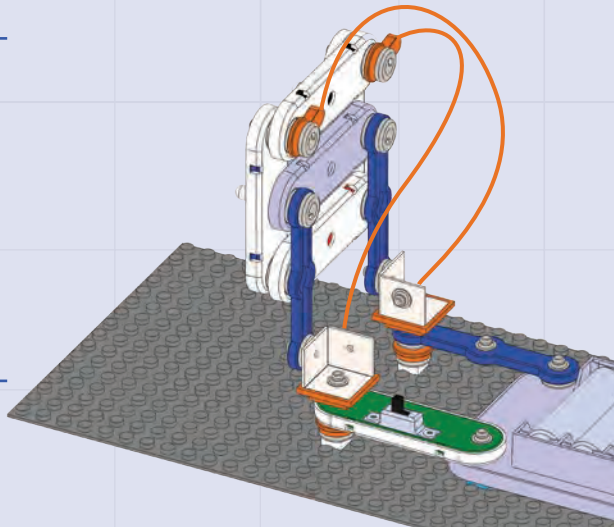

6

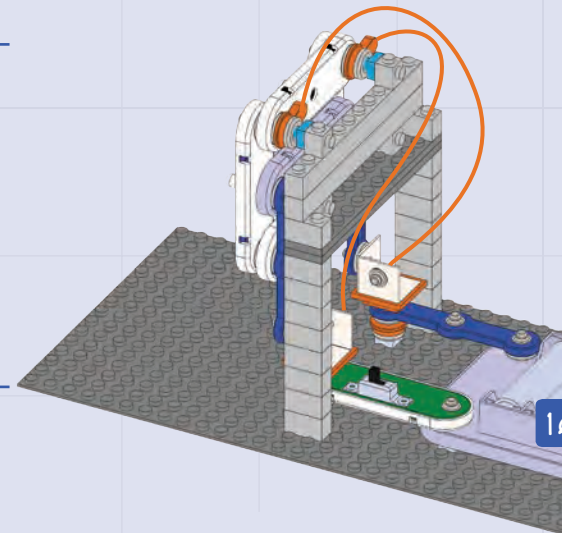
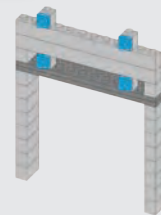



# Project 6

# CROSS OF LIGHTS

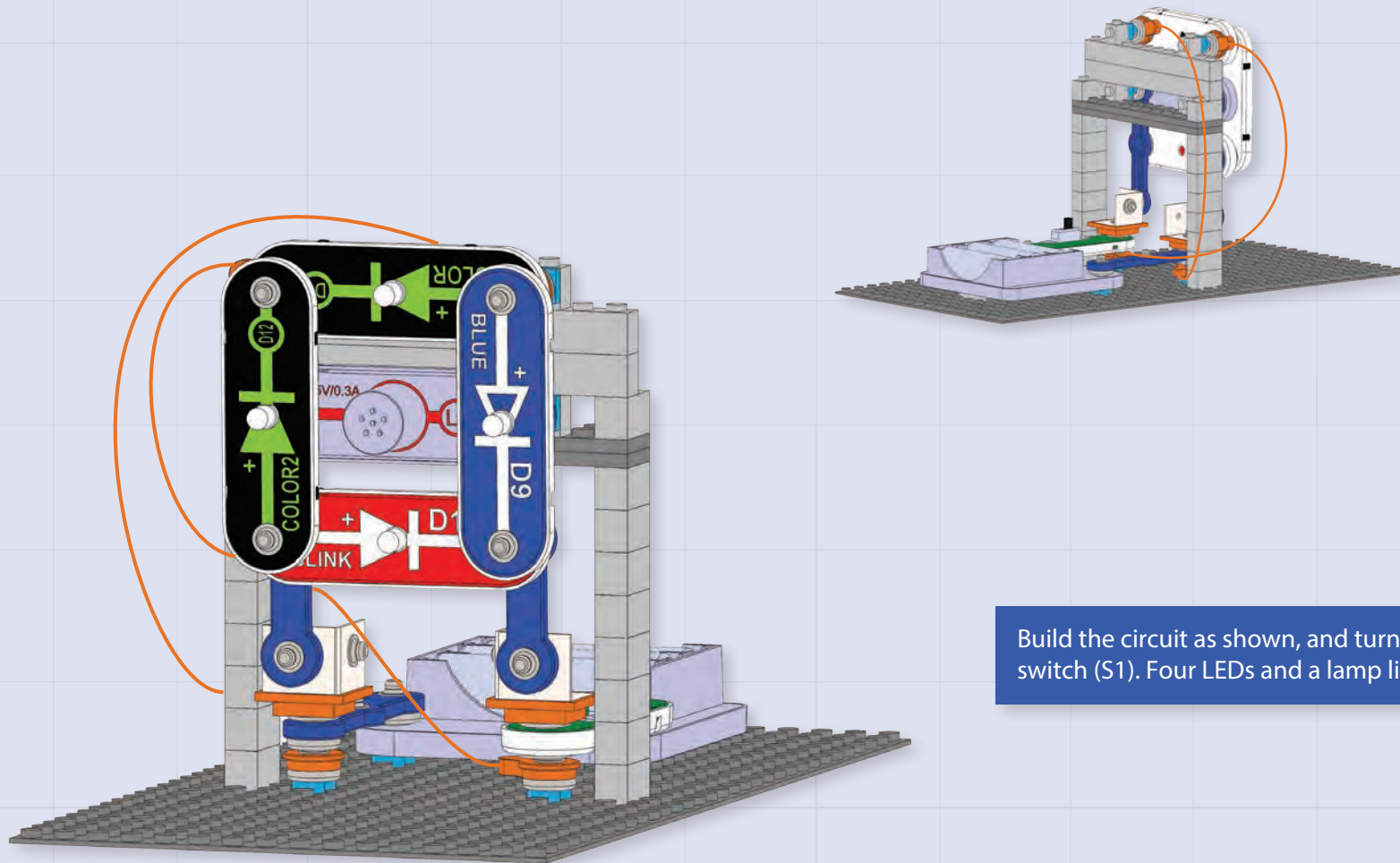

Build the circuit as shown, and turn on the slide switch (S1). Four LEDs and a lamp light.



# Project 7

# BRIC TOWER

1

4X

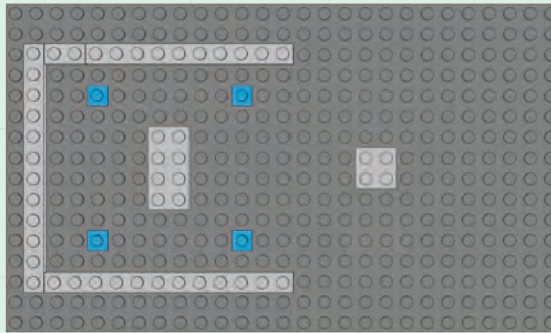
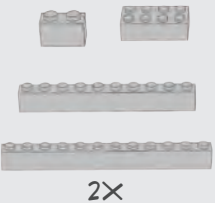

2

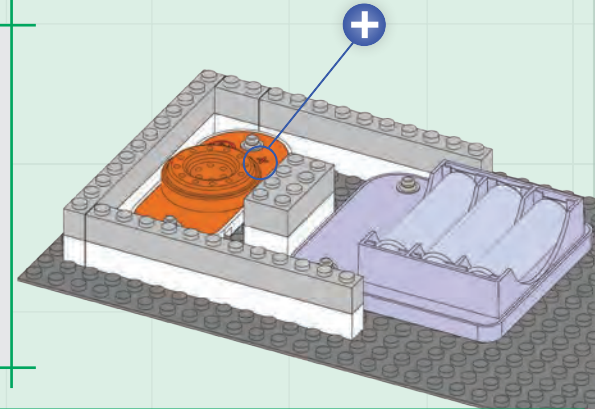
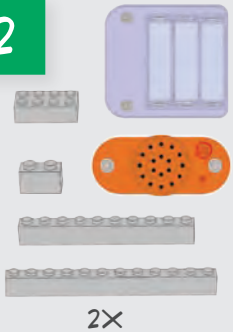

3

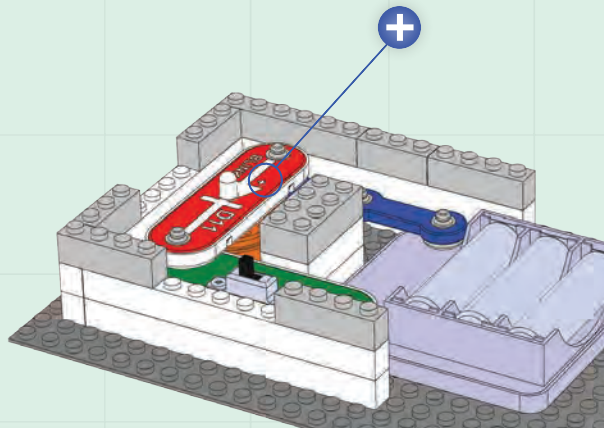
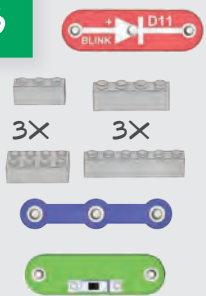

4

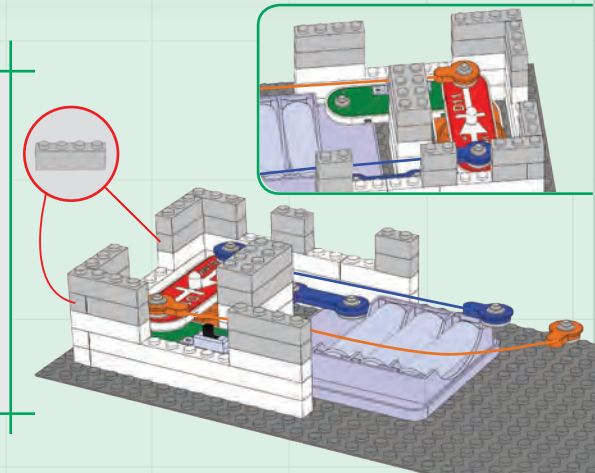
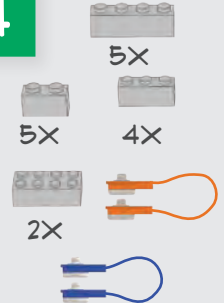

5

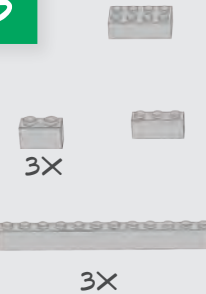

Note: You can omit the sound by removing the melody IC (move the blink red LED (D11) to where the melody IC was).

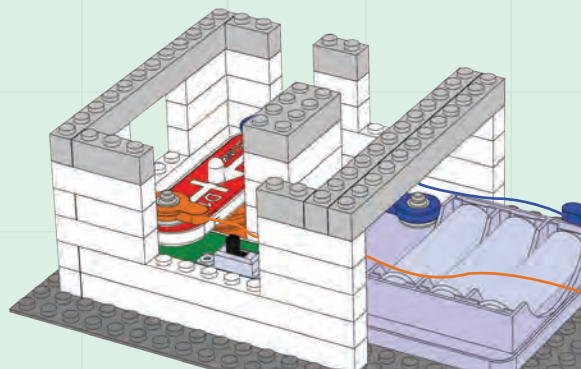

6

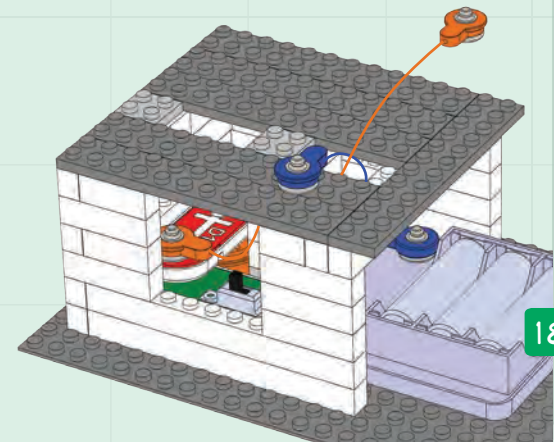
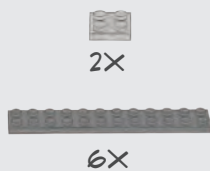



# Project 7 BRIC TOWER

7

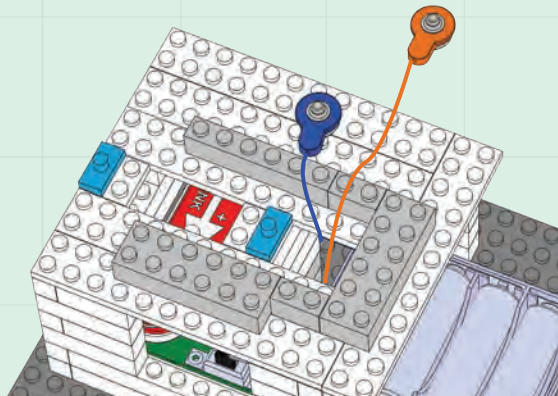
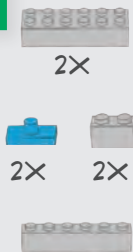

8

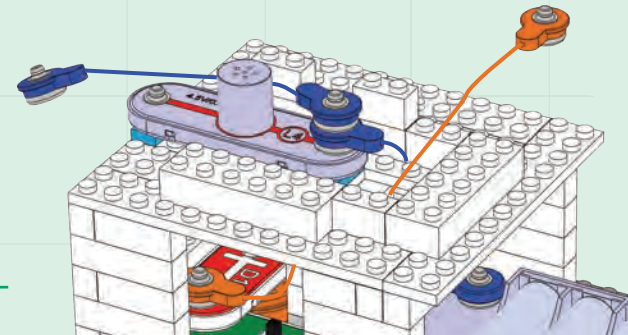

9

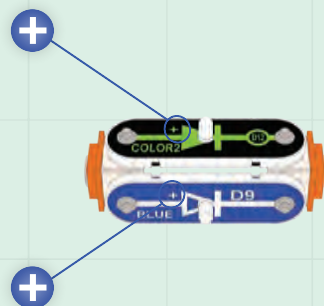
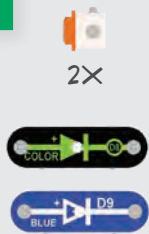

10

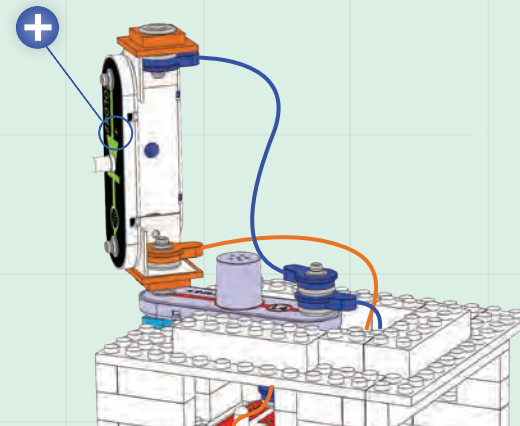

Add 2 wires, one end loose:

11

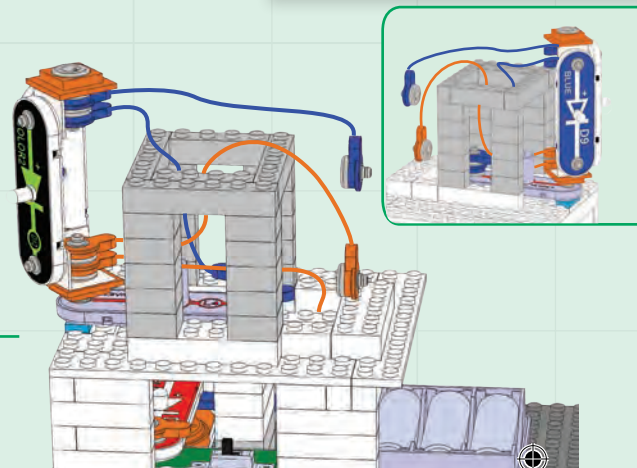
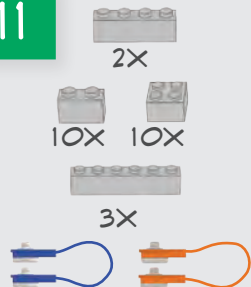

12

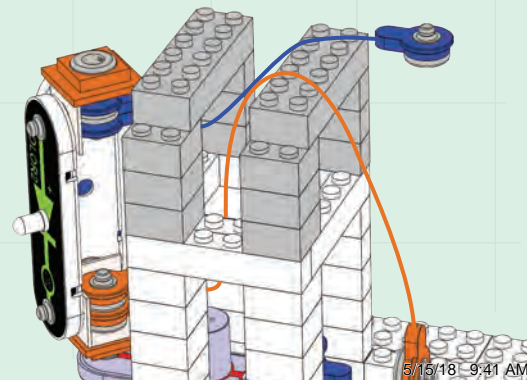
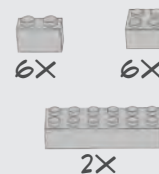



# Project 7 BRIC TOWER

13

4x 4x

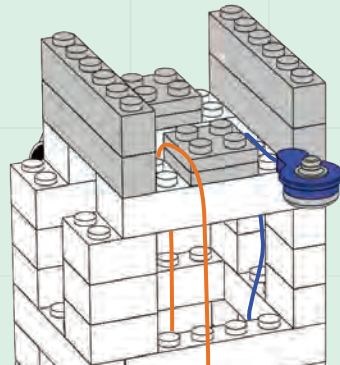

14

3x 2x  
2x

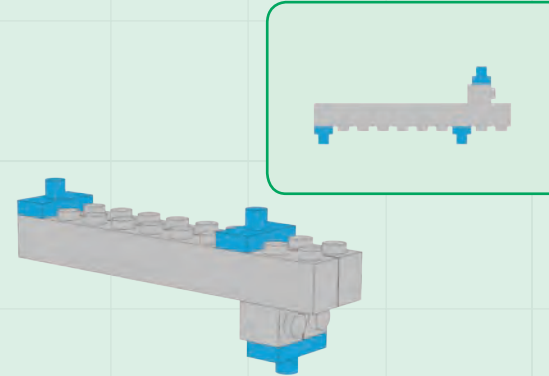

15

4x  
2x

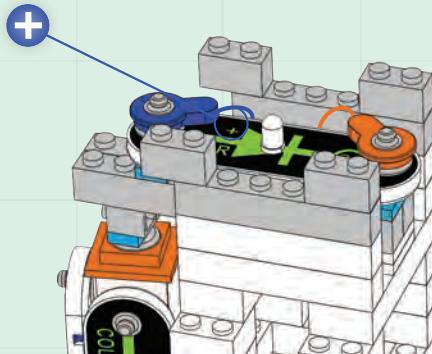

16

2x

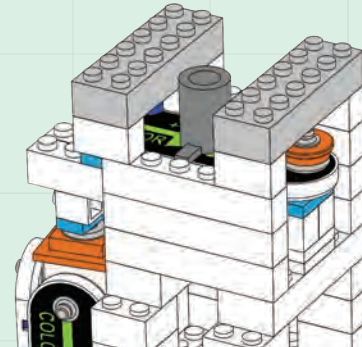

17

2x  
2x

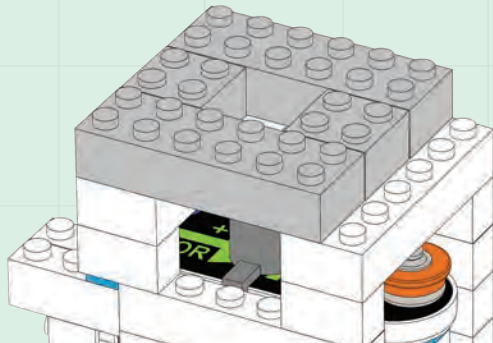

18

1x  
2x

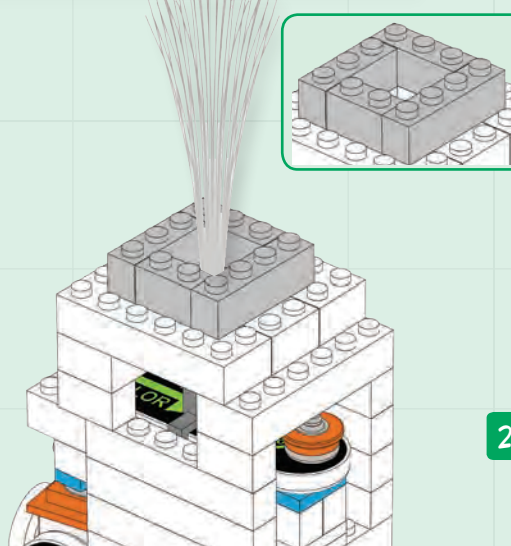

# Project 7

# BRIC TOWER

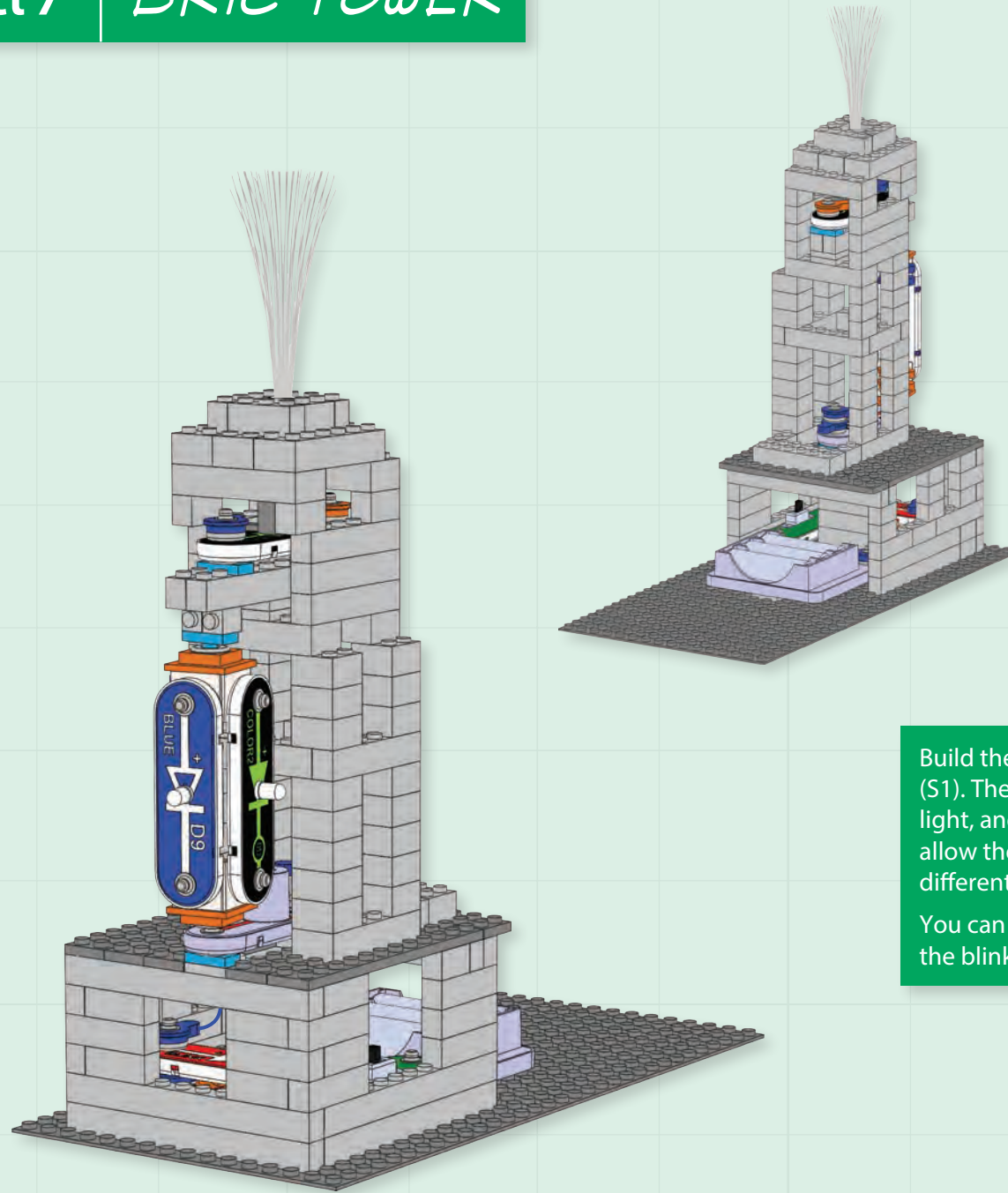

Build the circuit as shown, and turn on the slide switch (S1). The four LEDs (D8, D9, D11, & D12) and lamp (L4) light, and the melody IC (U32) plays tunes. The 3D snaps allow the blue and blink red LEDs to be rotated to shine in different directions. Dim the room lights for best effects. You can omit the sound by removing the melody IC (move the blink red LED (D11) to where the melody IC was).





# Project 8

# BRIC BRIDGE

1

2X 4X

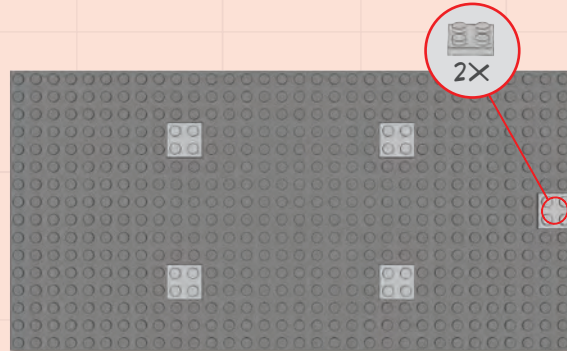

2

1X  
2X  
2X

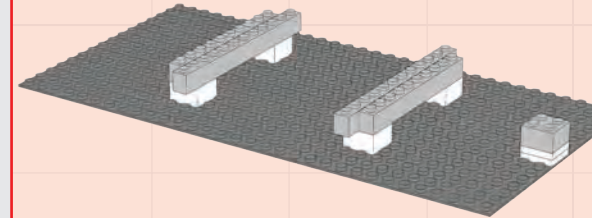

3

6X

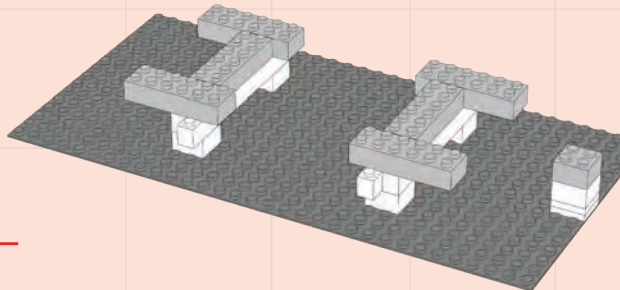

4

4X 4X  
4X 3X  
2X  
X6

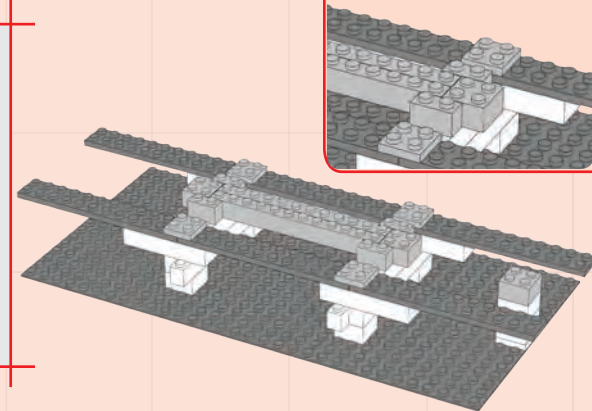

5

8X 2X  
4X 2X  
2X

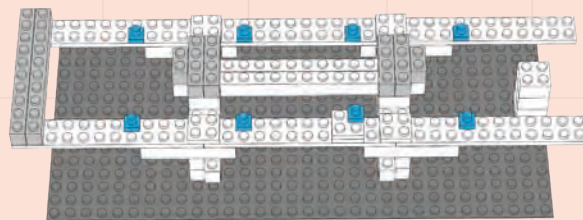

6

4X 2X

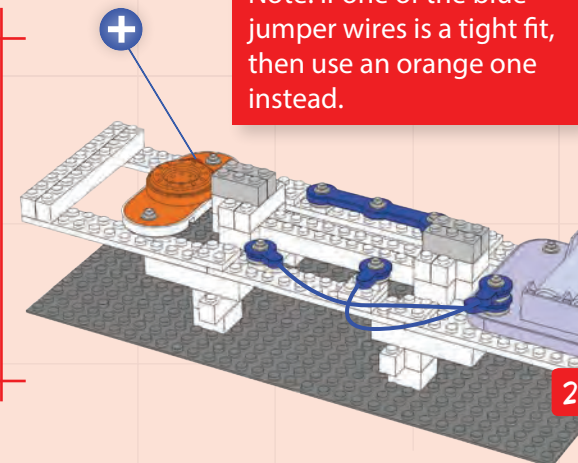

Note: if one of the blue jumper wires is a tight fit, then use an orange one instead.





# Project 8

# BRIC BRIDGE

7

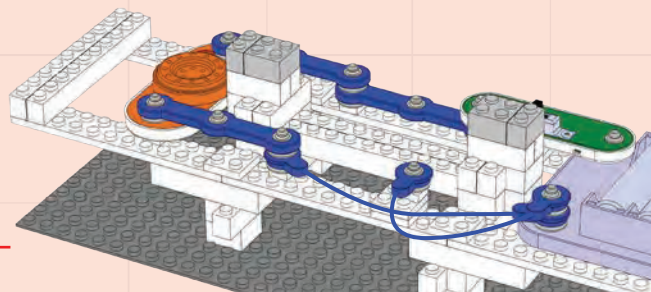
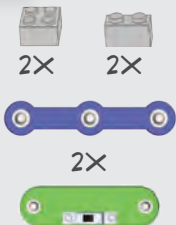

8

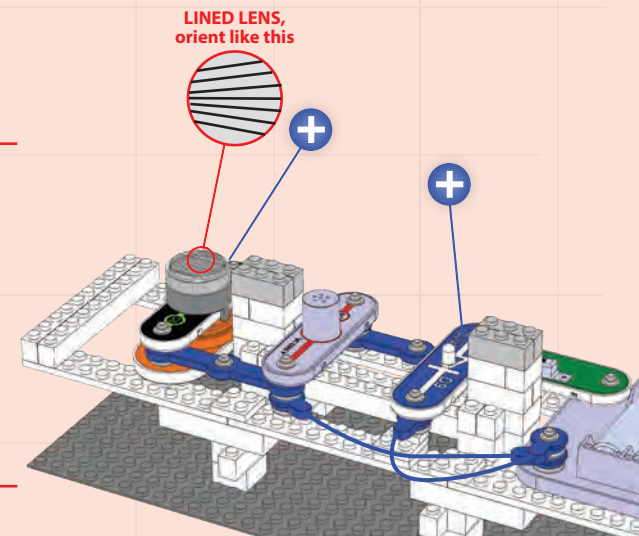

9

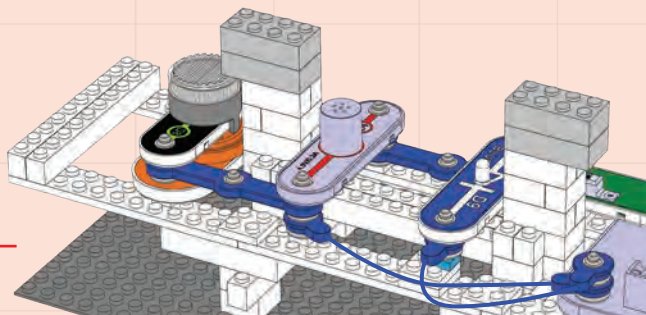

10

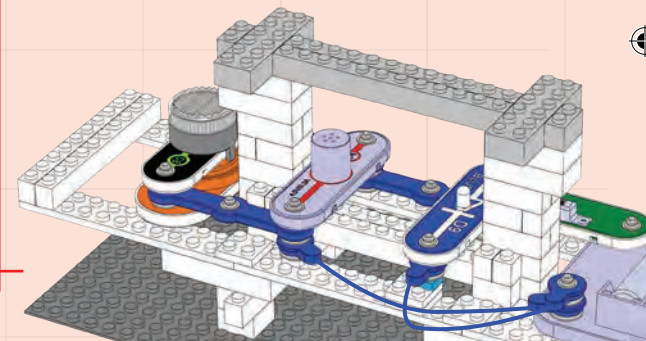
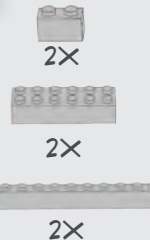

11

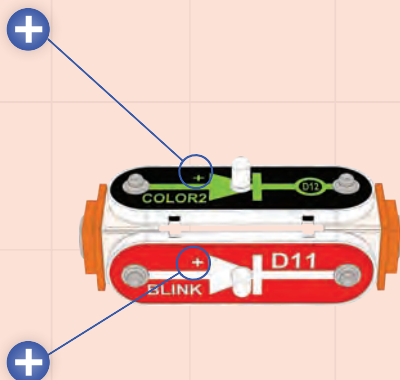

12

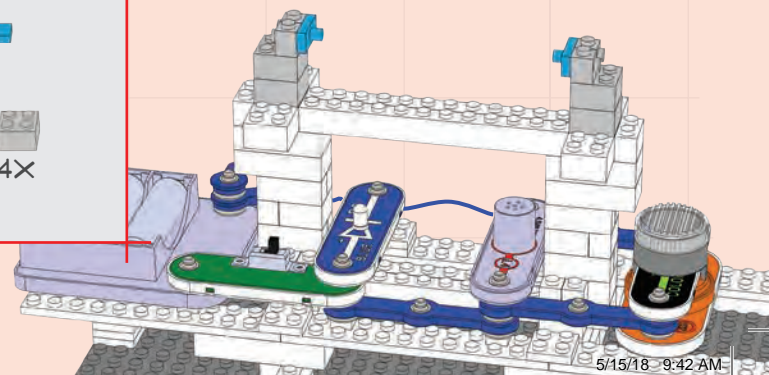
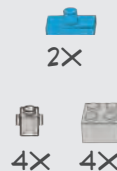



# Project 8

# BRIC BRIDGE

13

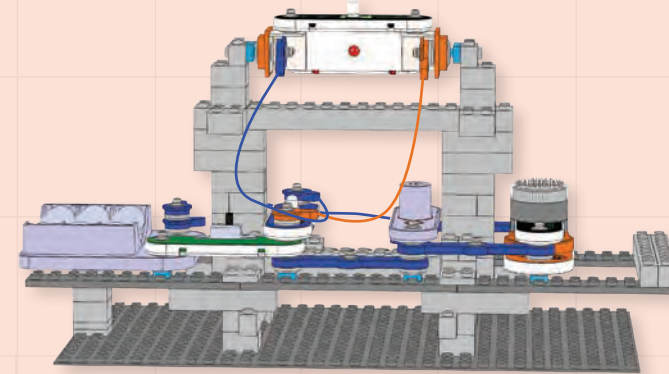
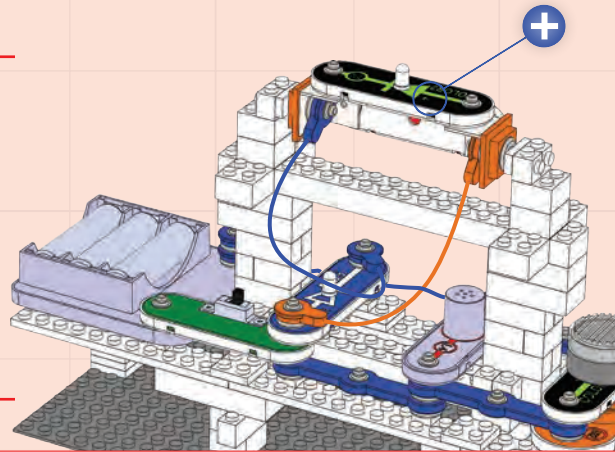

Build the circuit as shown, and turn on the slide switch (S1). The four LEDs (D8, D9, D11, & D12) and lamp (L4) light, and the melody IC (U32) plays tunes. The 3D snaps allow the blue and blink red LEDs to be rotated to shine in different directions. Dim the room lights for best effects.

You can omit the sound by removing the melody IC (move the color LED (D8) to where the melody IC was).

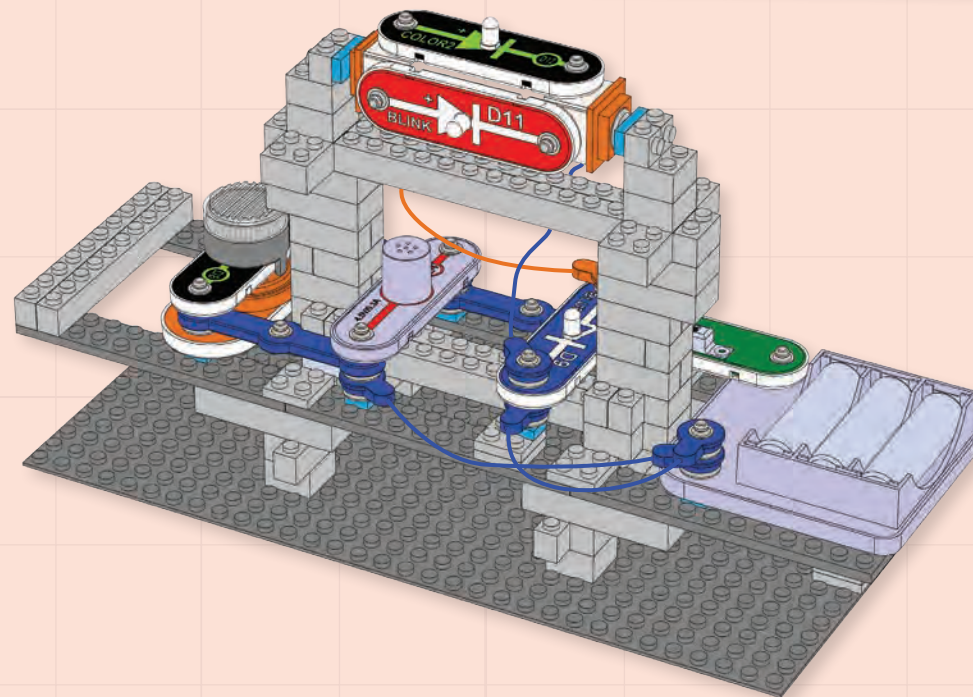





# Project 9

# HOUSE OF LIGHTS

Build the circuit as shown, and turn on the slide switch (S1). The four LEDs (D8, D9, D11, & D12) and lamp (L4) light. The 3D snaps allow the blue and color2 LEDs to be rotated to shine in different directions. Dim the room lights for best effects.

1

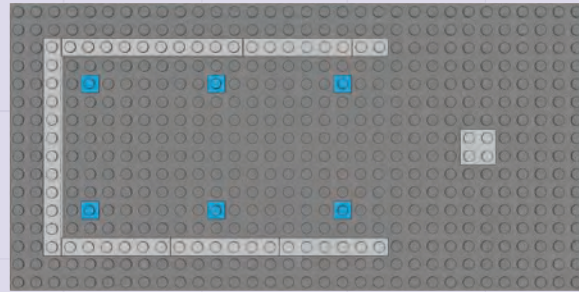
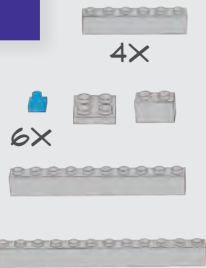

2

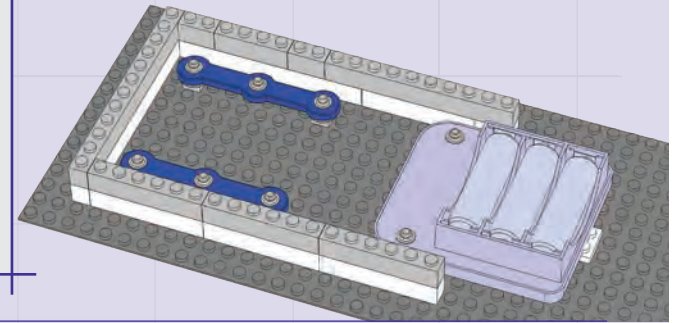
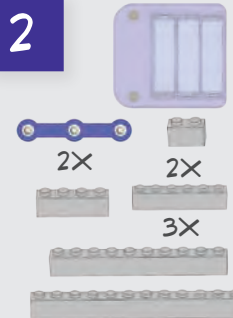

3

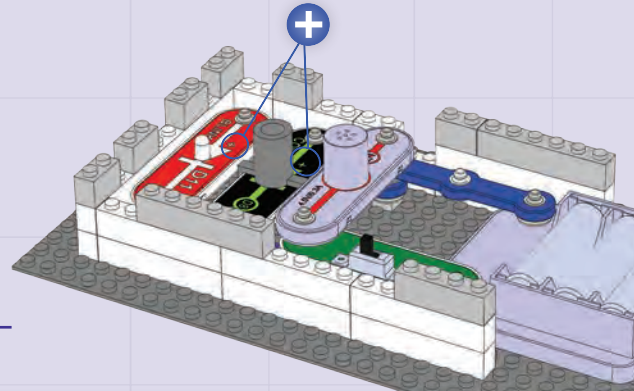

4

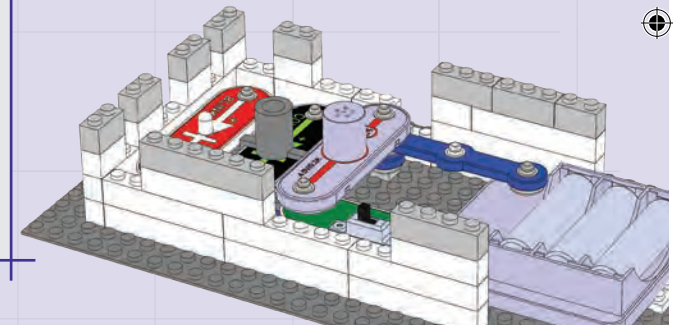

5

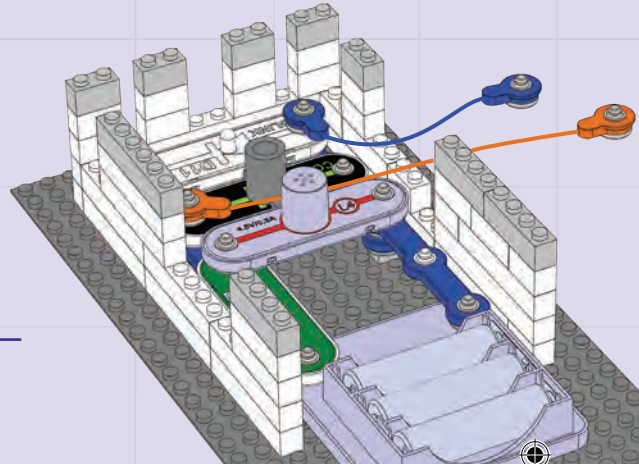
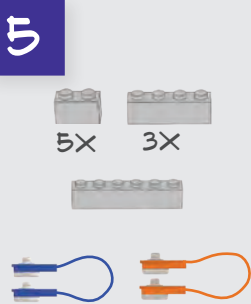

6

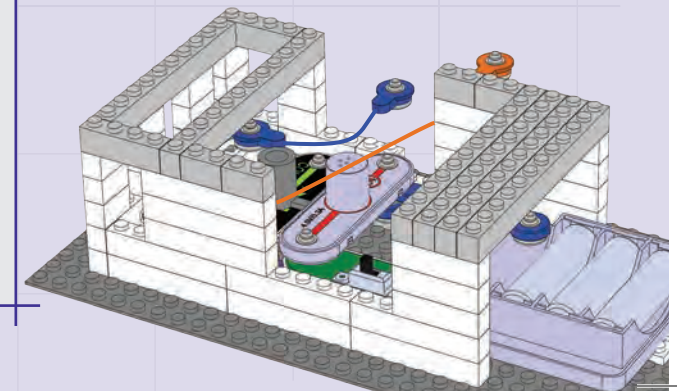
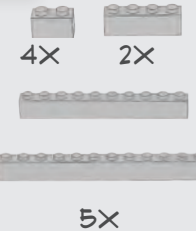





You can add sound by replacing the lamp (L4) with the melody IC ("+" side should be away from the S1 switch). You can also change the locations of the LEDs and lamp with each other.

# Project 9 HOUSE OF LIGHTS

**7**

2X 2X  
2X 2X  
6X

**8**

2X  
4X

**9**

4X 2X  
2X

**10**

2X 2X  
3X 8X 4X  
2X

**11**

6X

BLUE D9  
COLOR2

Project 10

BRIC MAMMAL

1

- 3X
- 3X
- 
- 6X

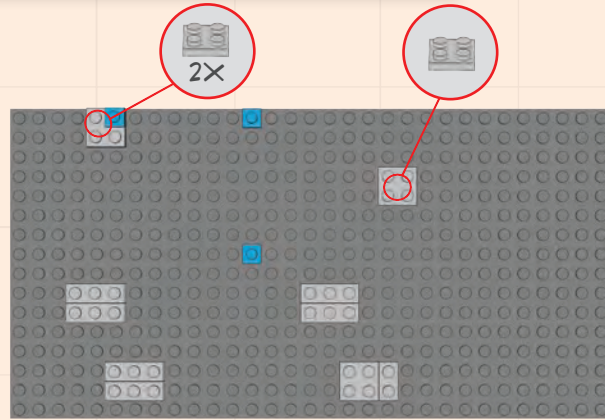

2

- 
- 16X

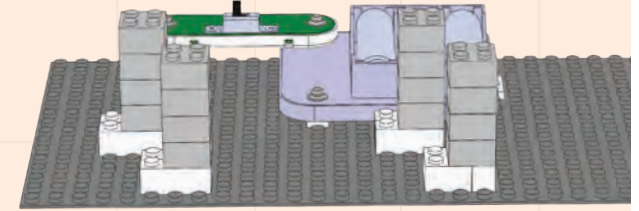

3

- 4X

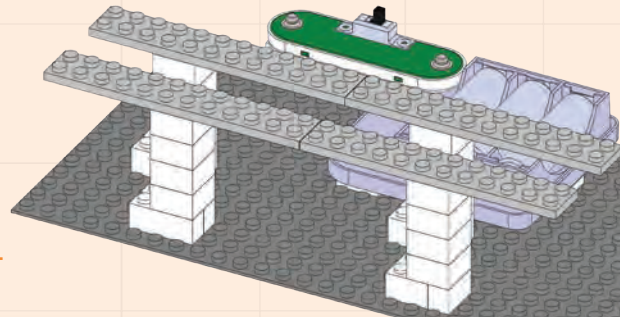

4

- 2X
- 3X
- 2X
- 2X

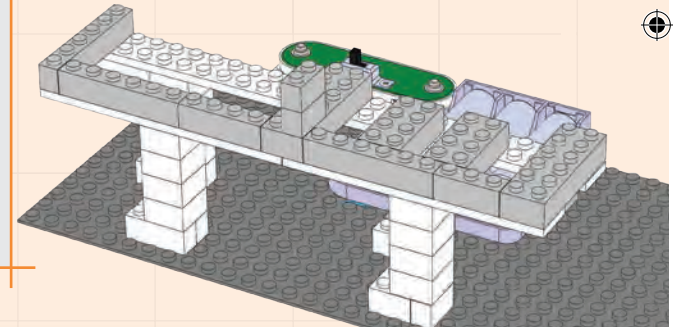

5

- 4X
- 4X
- 5X

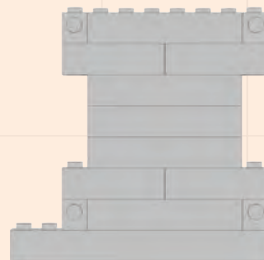

6

- 4X

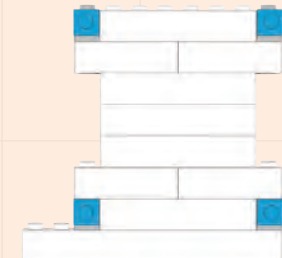



# Project 10

# BRIC MAMMAL

7

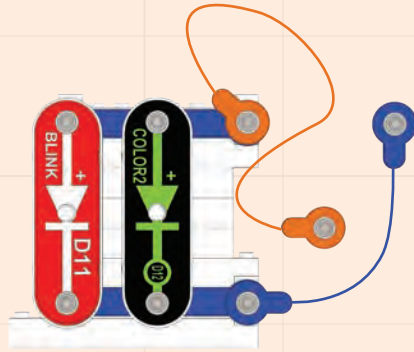
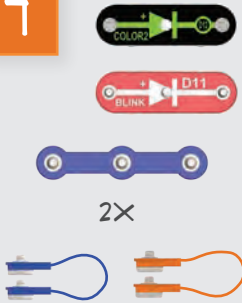

8

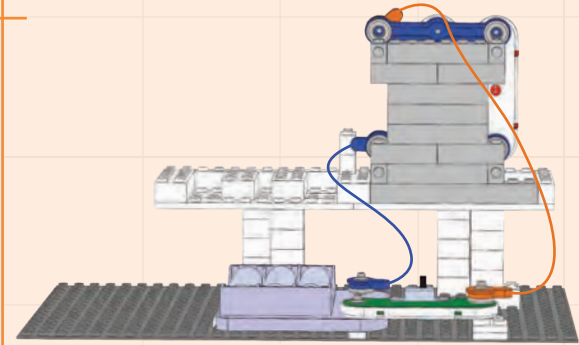

9

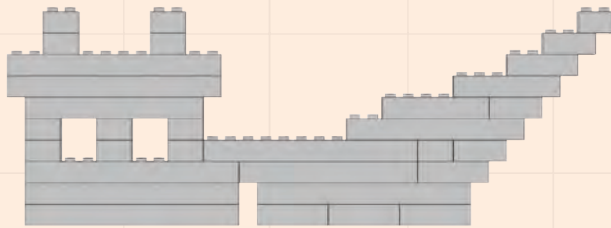
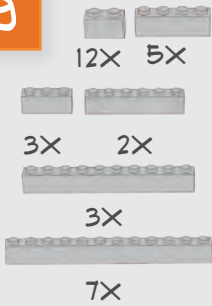

10

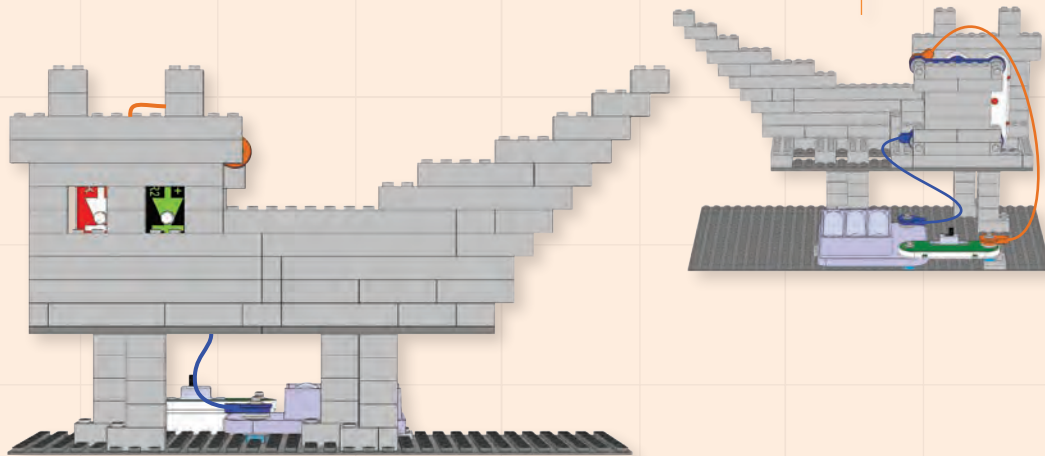
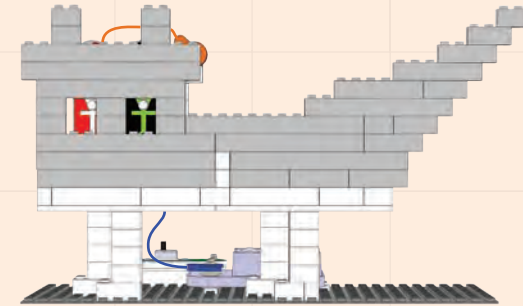

Build the circuit as shown, and turn on the slide switch (S1). The LEDs (D11, & D12) light.

If you look straight at the structure it resembles a mammal, with eyes that light up. You can adjust the position of the wires so they are less visible. You can replace the LEDs with different ones if desired.





# Project 11

# LEDS IN SERIES & PARALLEL

1



6X

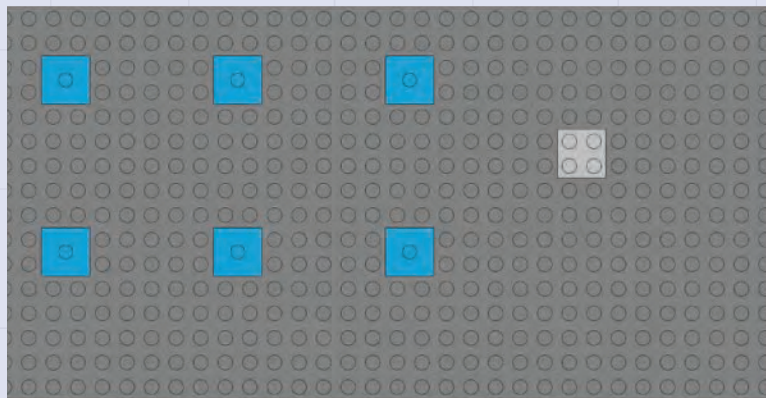

2



2X

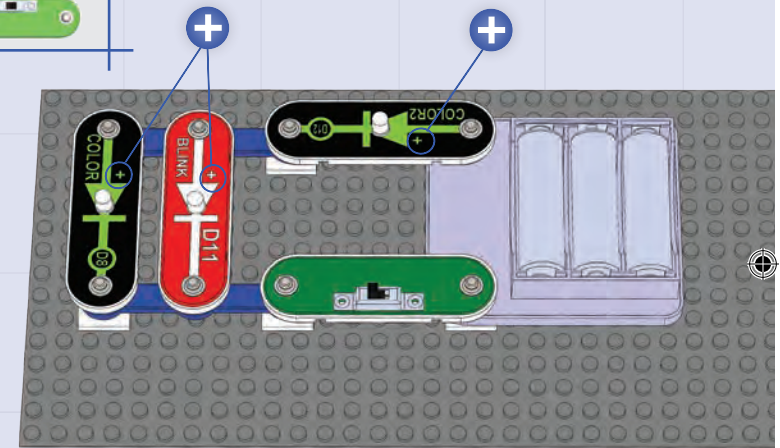

Build the circuit as shown, and turn on the slide switch (S1). The LEDs (D8, D11, & D12) light; watch how their patterns change.

Try swapping the LED locations and replacing one with the blue LED (D9); try all combinations and see how the effects change. You can also place the unused 3-snap wire where the color2 LED is and see how the circuit changes.

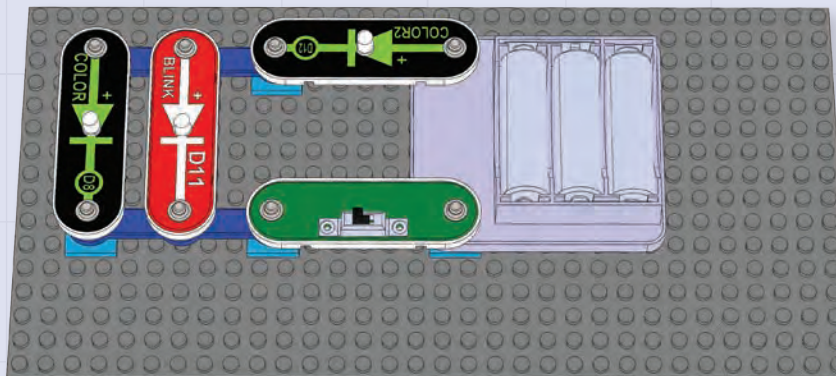

Here the color LED and blink red LED are connected in parallel, and then connected in series with the color2 LED, to produce some interesting effects. The electricity from the batteries flows through the color2 LED, then splits up between the color and blink red LEDs, then recombines in the switch before returning to the batteries.

When LEDs are connected in series the battery voltage may not be strong enough to fully turn them on. Red light is easier to produce than the other colors, and so turns on more easily.



# Project 12

# BRIC BUILDING

1

- 4X
- 4X
- 3X

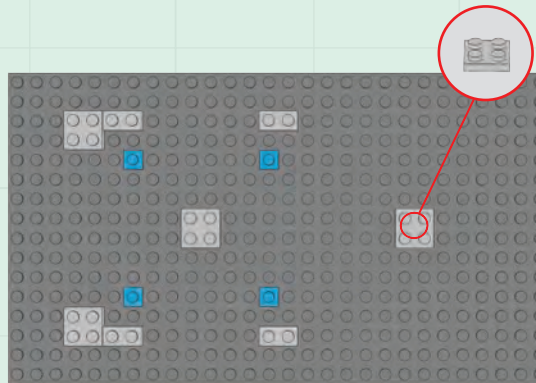

2

- 2X
- 
- 
- 
- 
- 

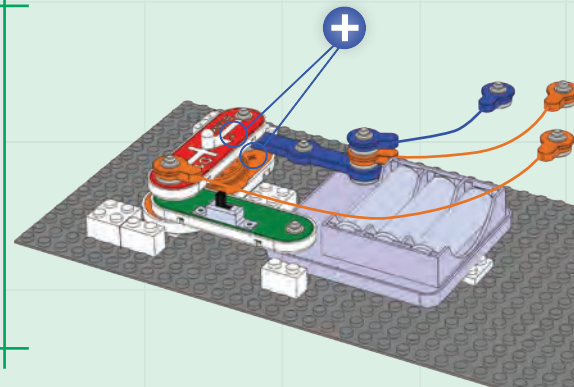

3

- 16X
- 12X

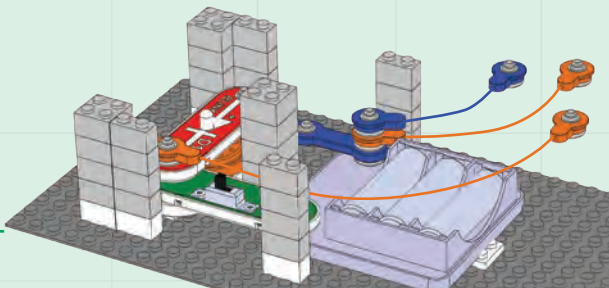

4

- 
- 2X
- 2X

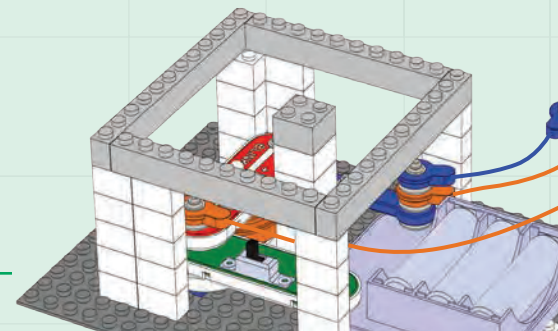

5

- 
- 4X
- 3X
- 2X
- 6X

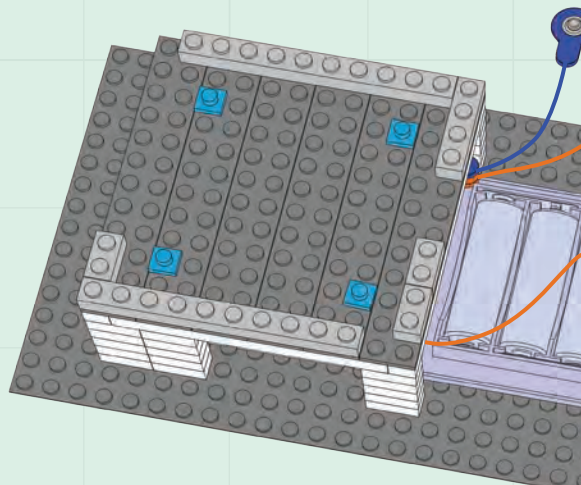

6

- 2X
- 
- 

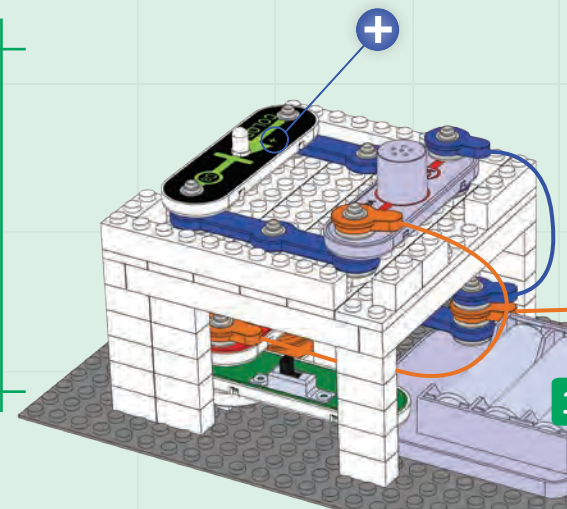



# Project 12 BRIC BUILDING

7

- 10X 10X
- 10X
- 10X

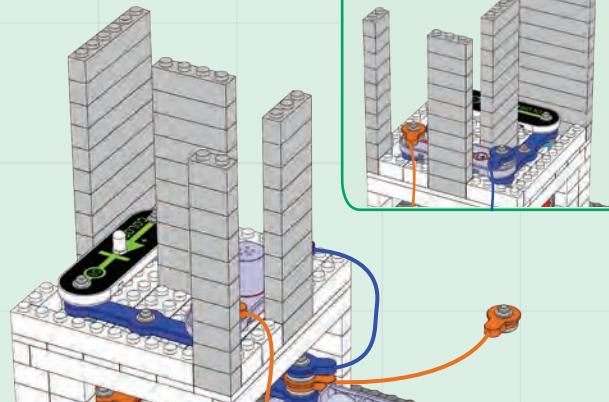

8

- COLOR2 LED
- BLUE LED D9
- 2X
- 2X

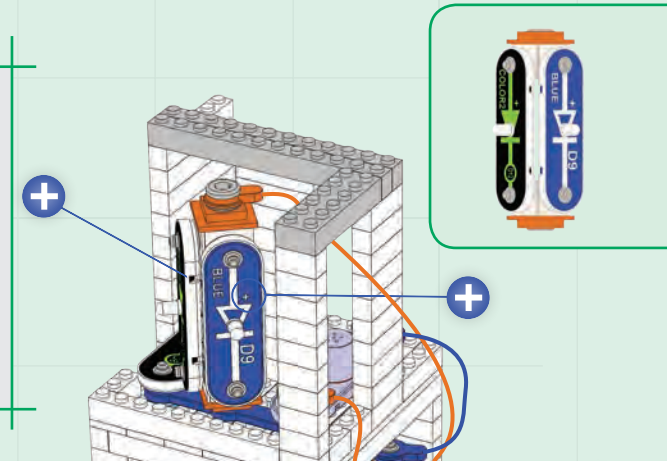

9

- 2X
- 2X
- 2X

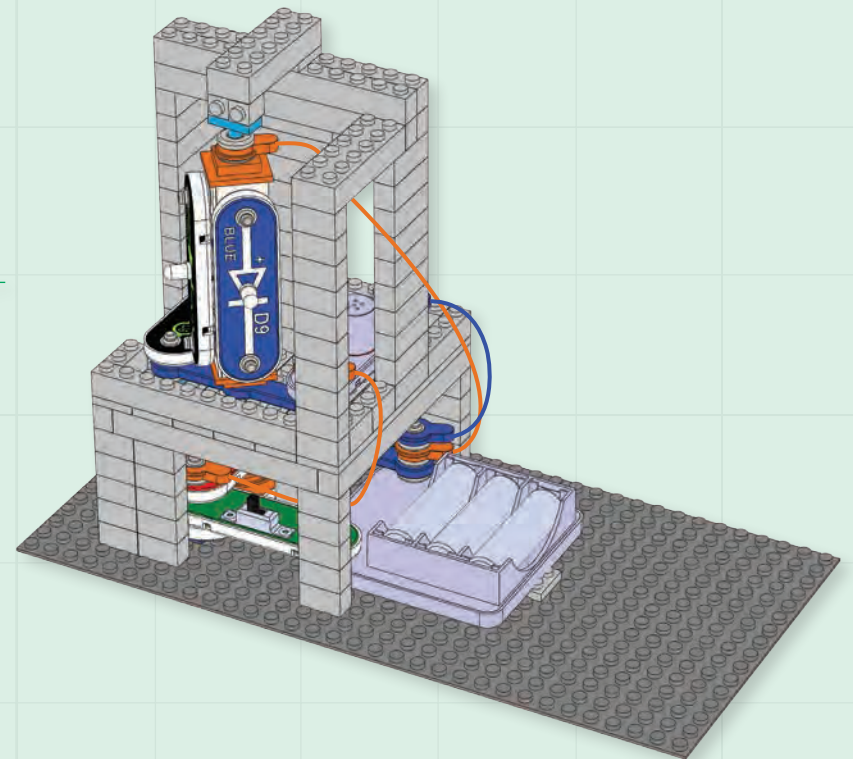
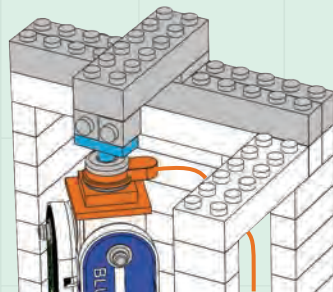

Build the circuit as shown, and turn on the slide switch (S1). The four LEDs (D8, D9, D11, & D12) and lamp (L4) light, and the melody IC (U32) plays tunes. The 3D snaps allow the blue and color2 LEDs to be rotated to shine in different directions. Dim the room lights for best effects. You can remove the melody IC if desired, just shift the blink red LED (D11) to where the melody IC was.



# Project 13

# TRI-LEVEL HOUSE

1

- 4X [Blue Pin]
- 2X [Grey 1x2 Technic Brick]
- 2X [Grey 1x4 Technic Brick]

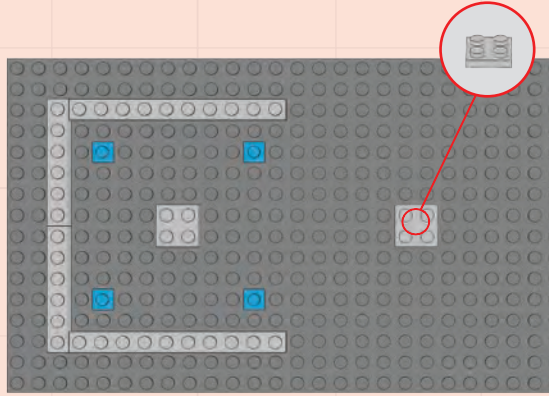

2

- [Purple Battery Pack]
- [Blue and Orange Wires]
- [Blue 3-Pin Connector]
- [Red LED with 'D11' and 'BLINK' text]
- [Green PCB]

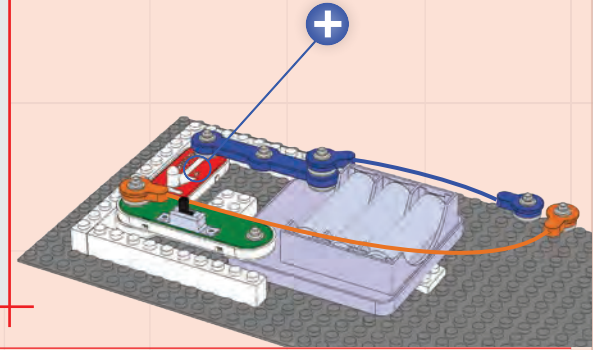

3

- 10X [Grey 1x2 Technic Brick]
- 4X [Grey 1x2 Technic Brick]
- 8X [Grey 1x2 Technic Brick]
- 2X [Grey 1x4 Technic Brick]
- 2X [Grey 1x6 Technic Brick]

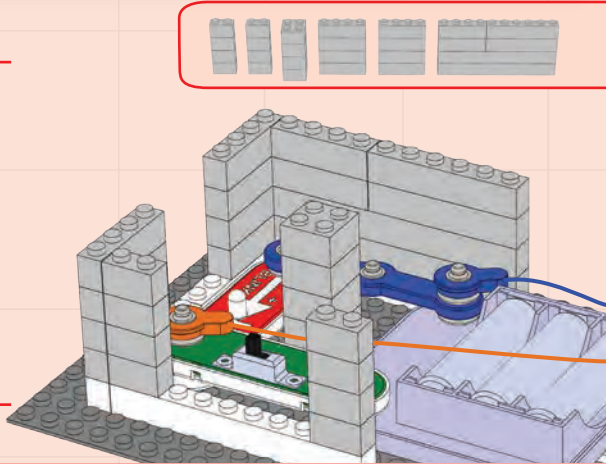

4

6X

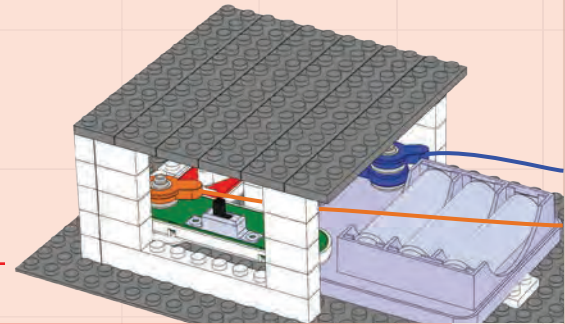

5

- 4X [Blue Pin]
- 5X [Grey 1x2 Technic Brick]
- 4X [Grey 1x2 Technic Brick]
- 3X [Grey 1x4 Technic Brick]

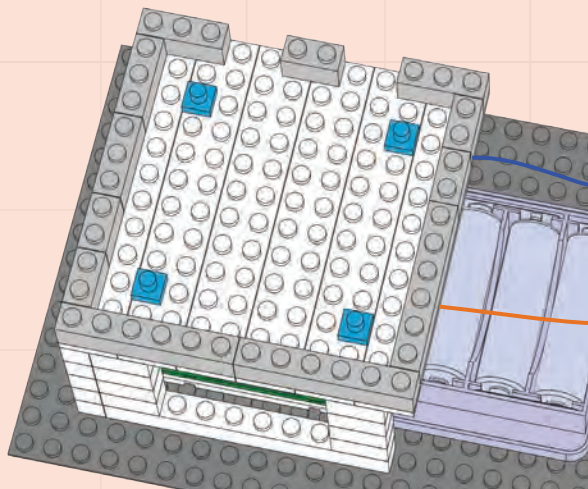

6

- 2X [Grey 1x2 Technic Brick]
- 2X [Grey 1x4 Technic Brick]
- 2X [Blue 3-Pin Connector]

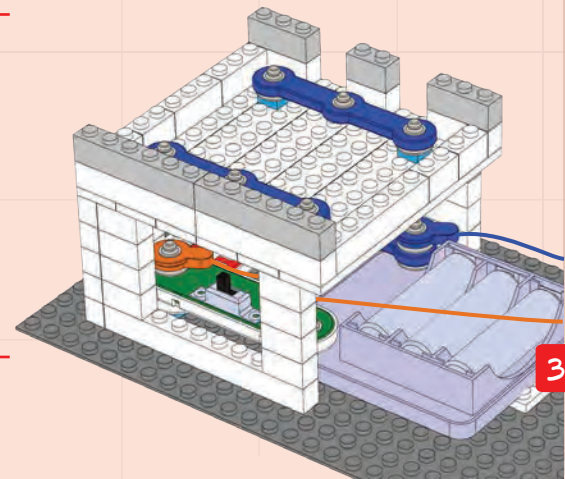

# Project 13 TRI-LEVEL HOUSE

7

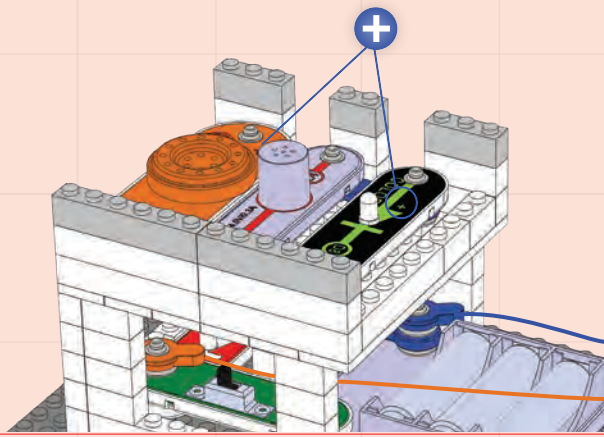
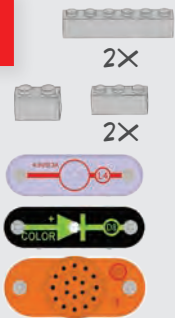

8

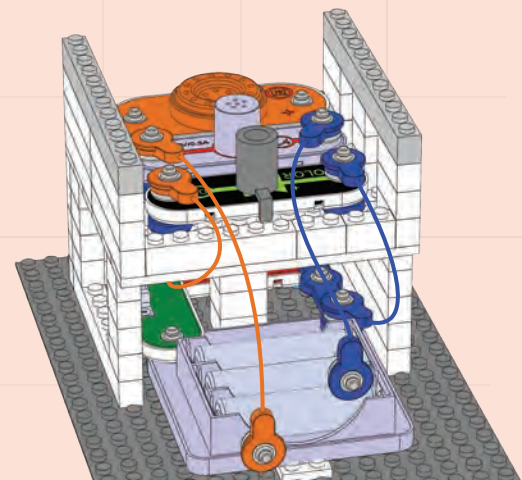
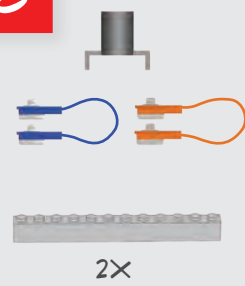

9

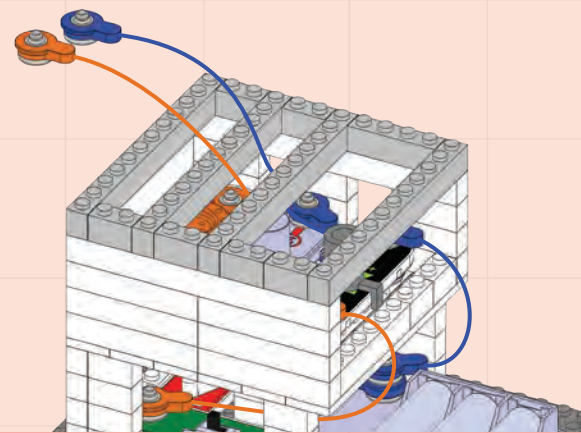
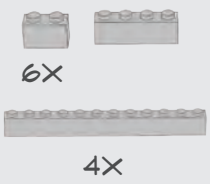

10

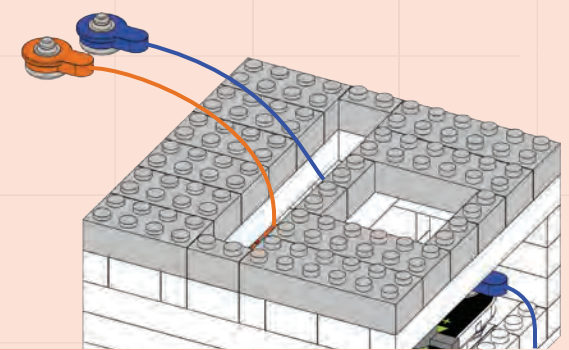
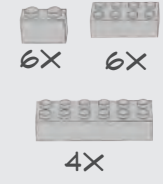

11

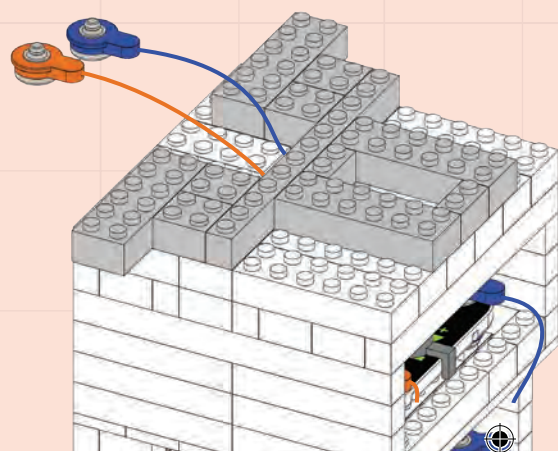
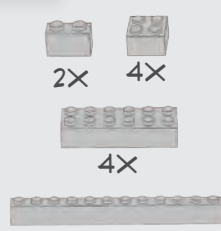

12

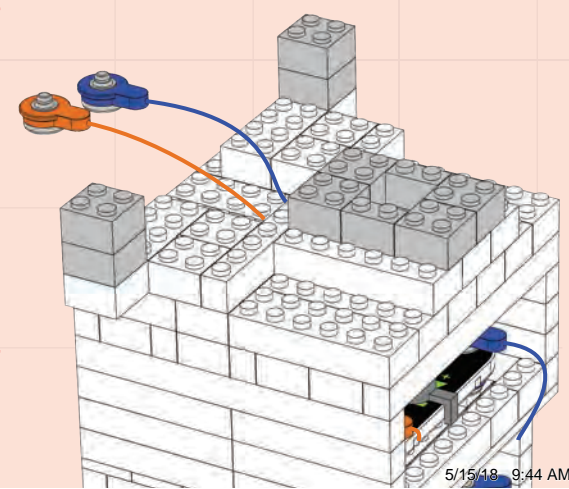
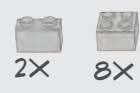



# Project 13 TRI-LEVEL HOUSE

13

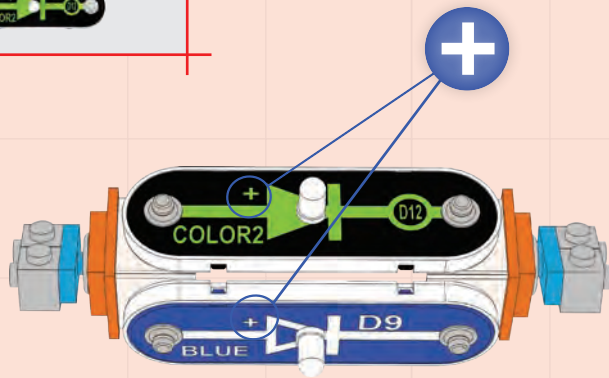
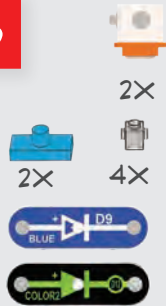

14

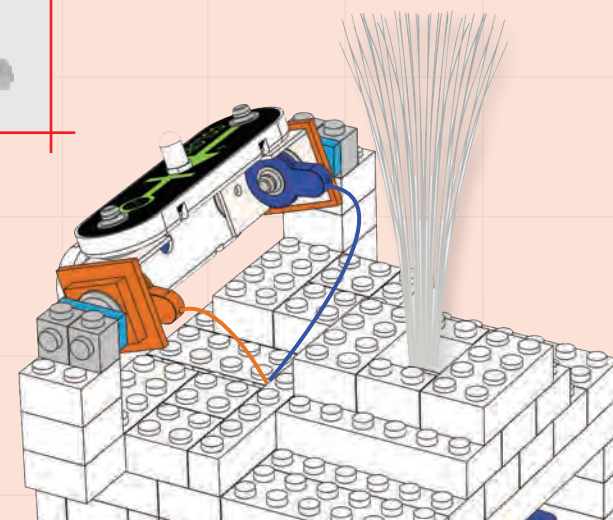
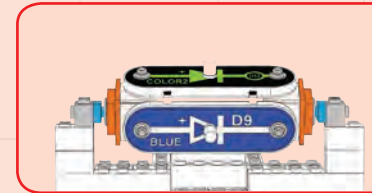
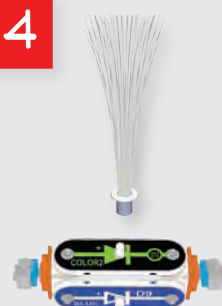

Build the circuit as shown, and turn on the slide switch (S1). The four LEDs (D8, D9, D11, & D12) and lamp (L4) light, and the melody IC (U32) plays tunes. The 3D snaps allow the blue and color2 LEDs to be rotated to shine in different directions. Dim the room lights for best effects.

You can remove the melody IC or re-arrange any of the lights if desired.

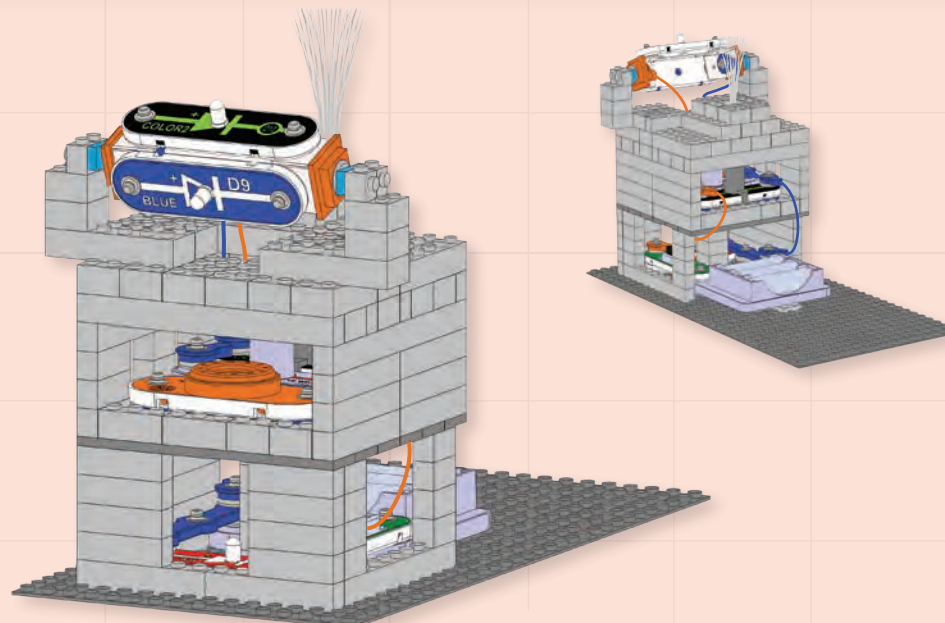



# Project 14 ELEVATED CIRCUIT

Build the circuit as shown, and turn on the slide switch (S1). The LEDs (D8 & D9) light, and the melody IC (U32) plays tunes. You can replace the LEDs and melody IC with any of the other lights.

- 1**
- 10X
  - 6X 22X
  - 6X 10X
  - 18X 4X

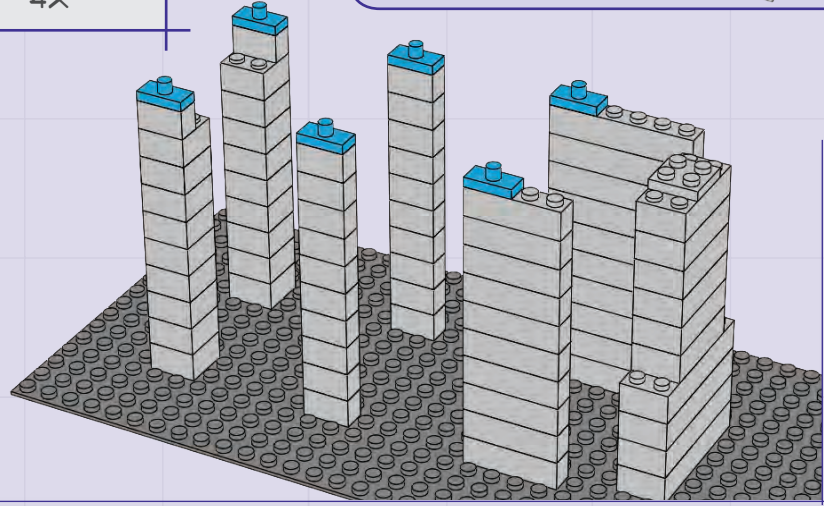
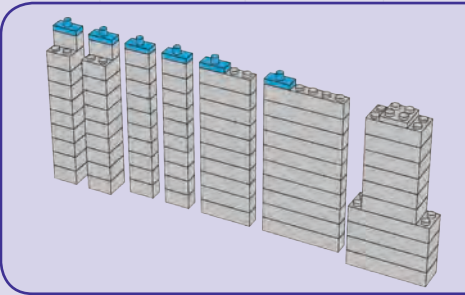

- 2**
- 3X
  - COLOR
  - BLUE D9
  - MELODY IC

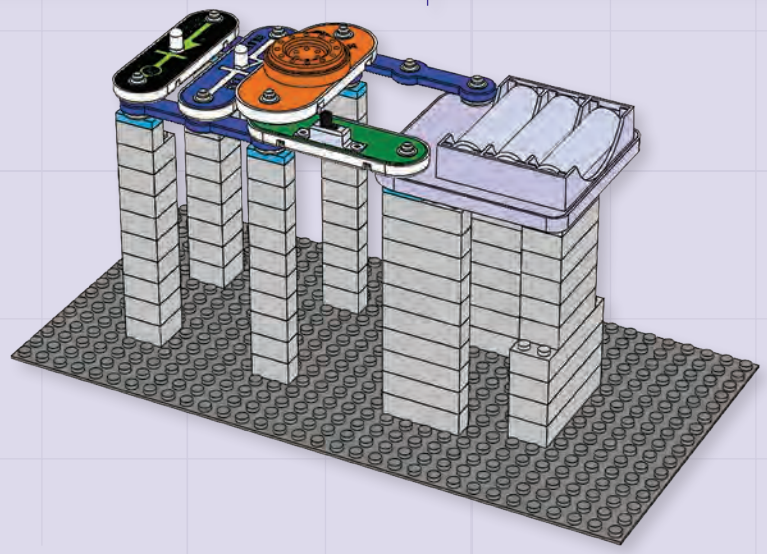
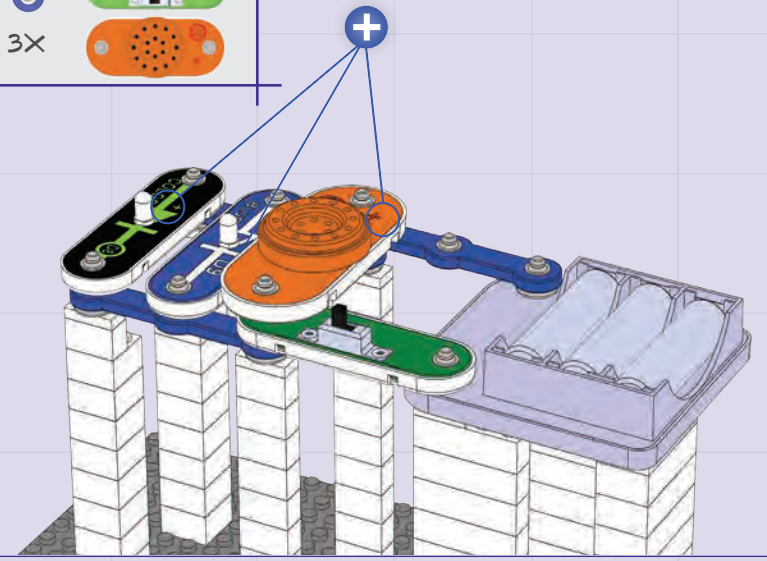

# Project 15 BI-LEVEL CIRCUIT

1

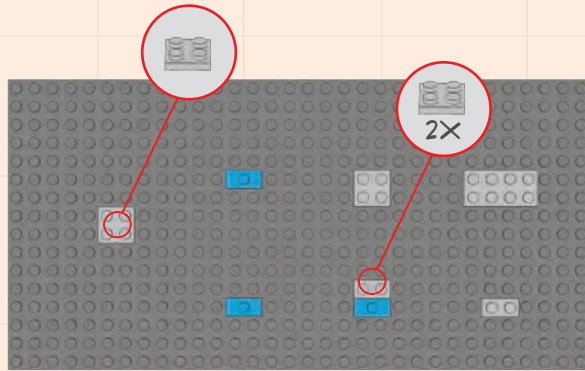
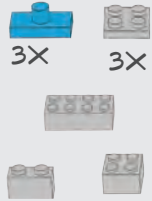

2

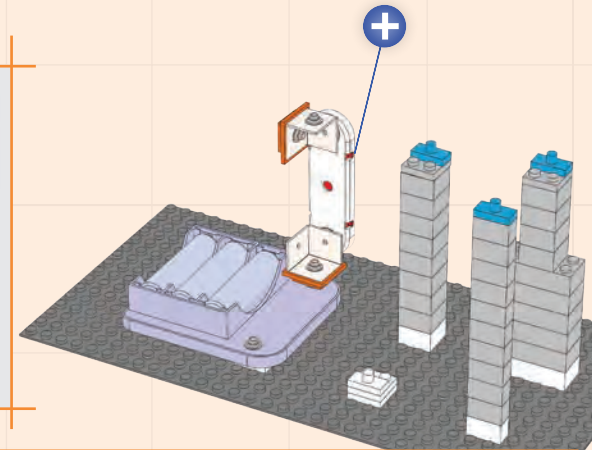
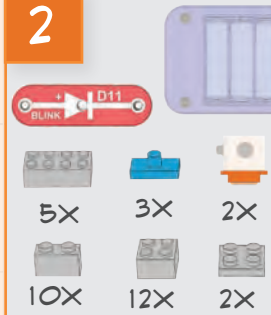

3

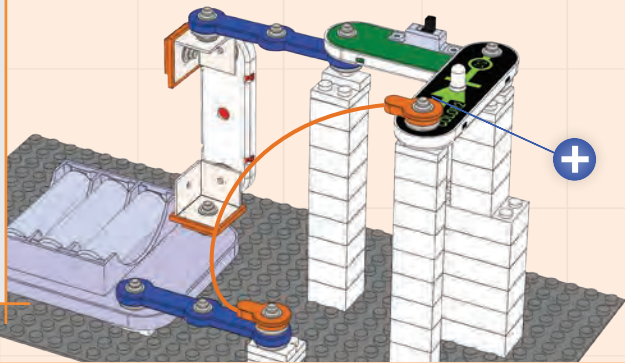

Build the circuit as shown, and turn on the slide switch (S1). The LEDs (D11 & D12) light in a blinking pattern. You can replace the LEDs with any other LEDs and see how the circuit changes.

As the blink red LED (D11) turns on and off, the brightness of the color2 LED (D12) also changes because those LEDs are connected in series. When components are connected in series, a change in one affects the others.

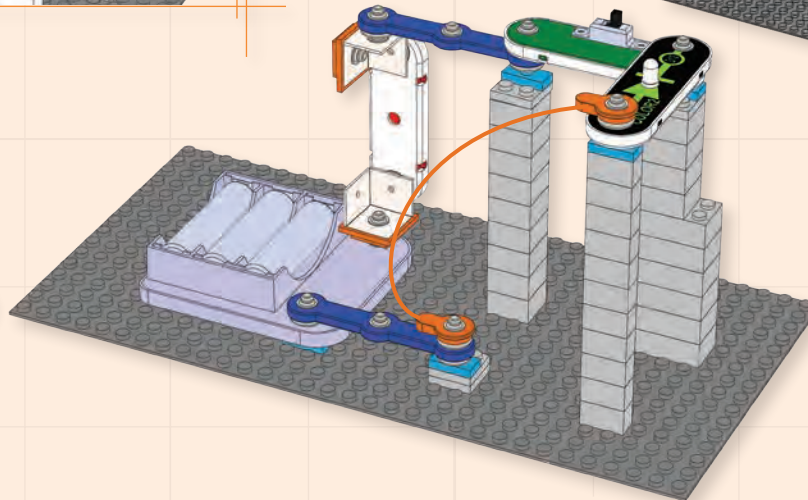









# Project 16 OVERHEAD LIGHT

7

2X

4X

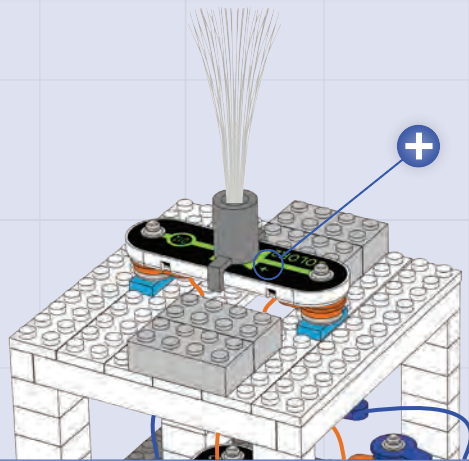

Build the circuit as shown, and turn on the slide switch (S1). The four LEDs (D8, D9, D11, & D12) and lamp (L4) light. Dim the room lights for best effects. You can re-arrange the lights as desired, or replace one with the melody IC (U32).

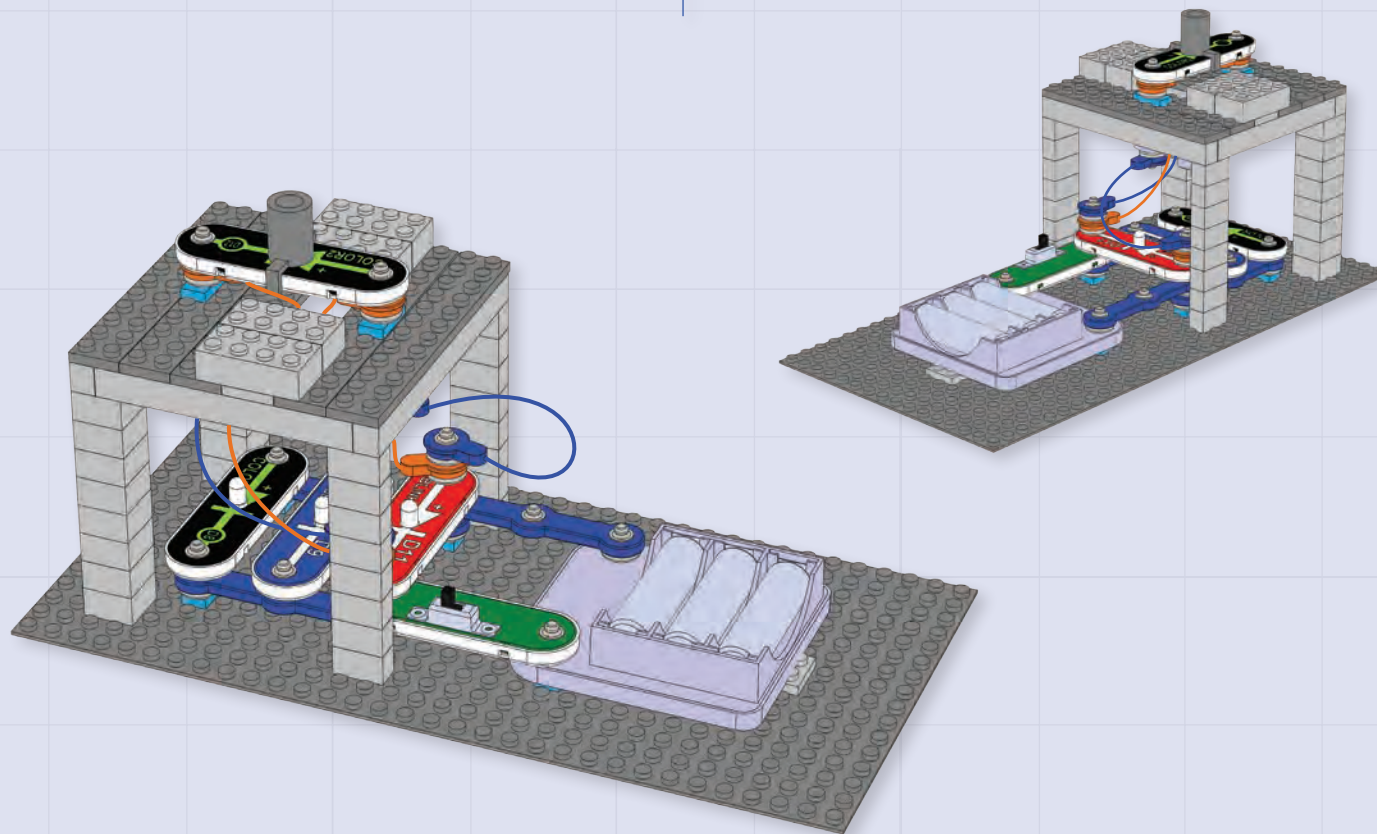

# Project 17 3 SHINE OUT

1

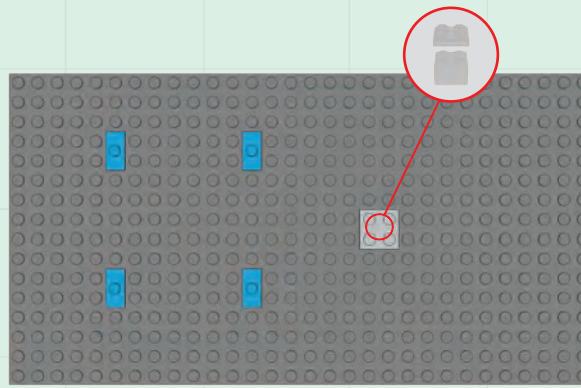

2

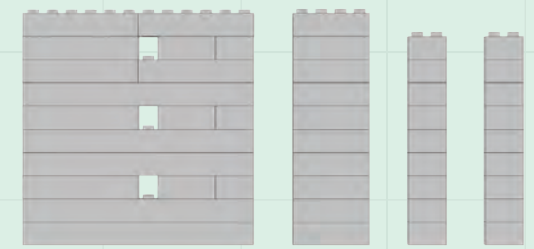
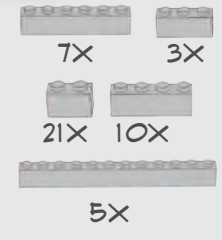

3

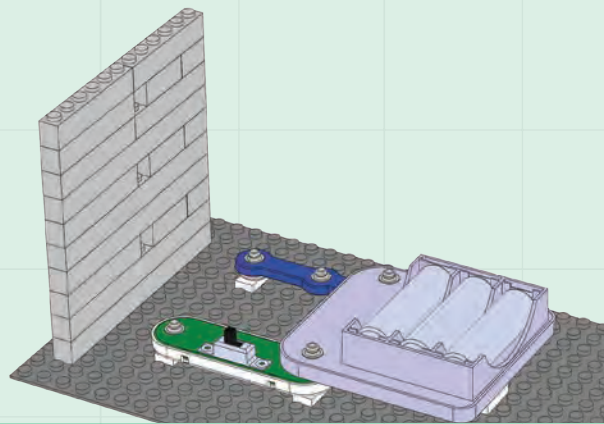
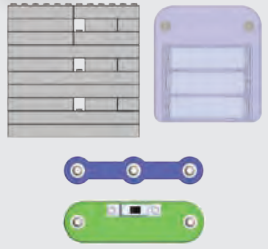

4

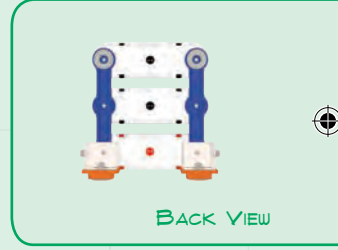
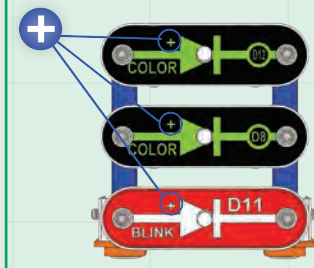

5

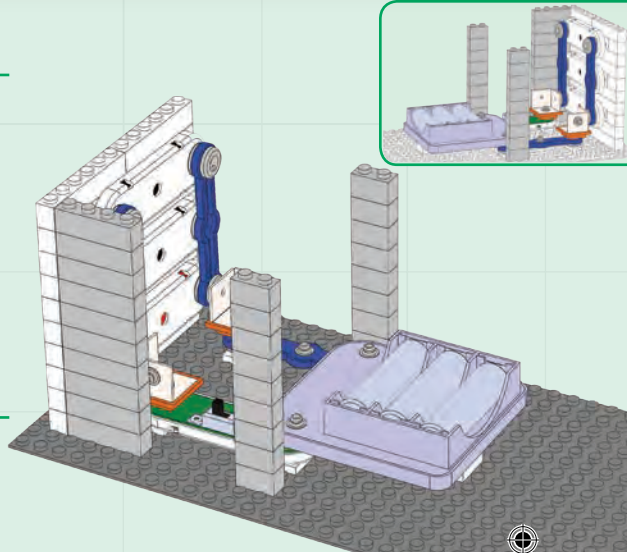
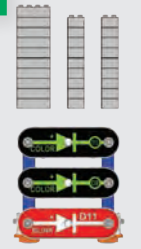

6

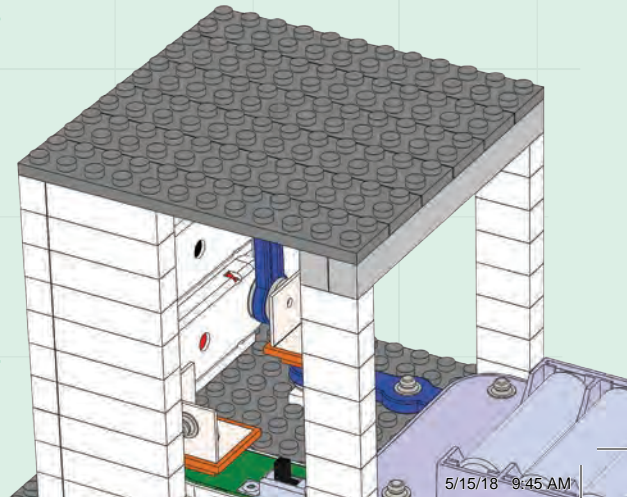
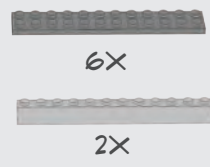



# Project 17 | 3 SHINE OUT

Build the circuit as shown, and turn on the slide switch (S1). The three LEDs (D8, D11, & D12) light. You can re-arrange the LEDs or replace one with the blue LED (D9).

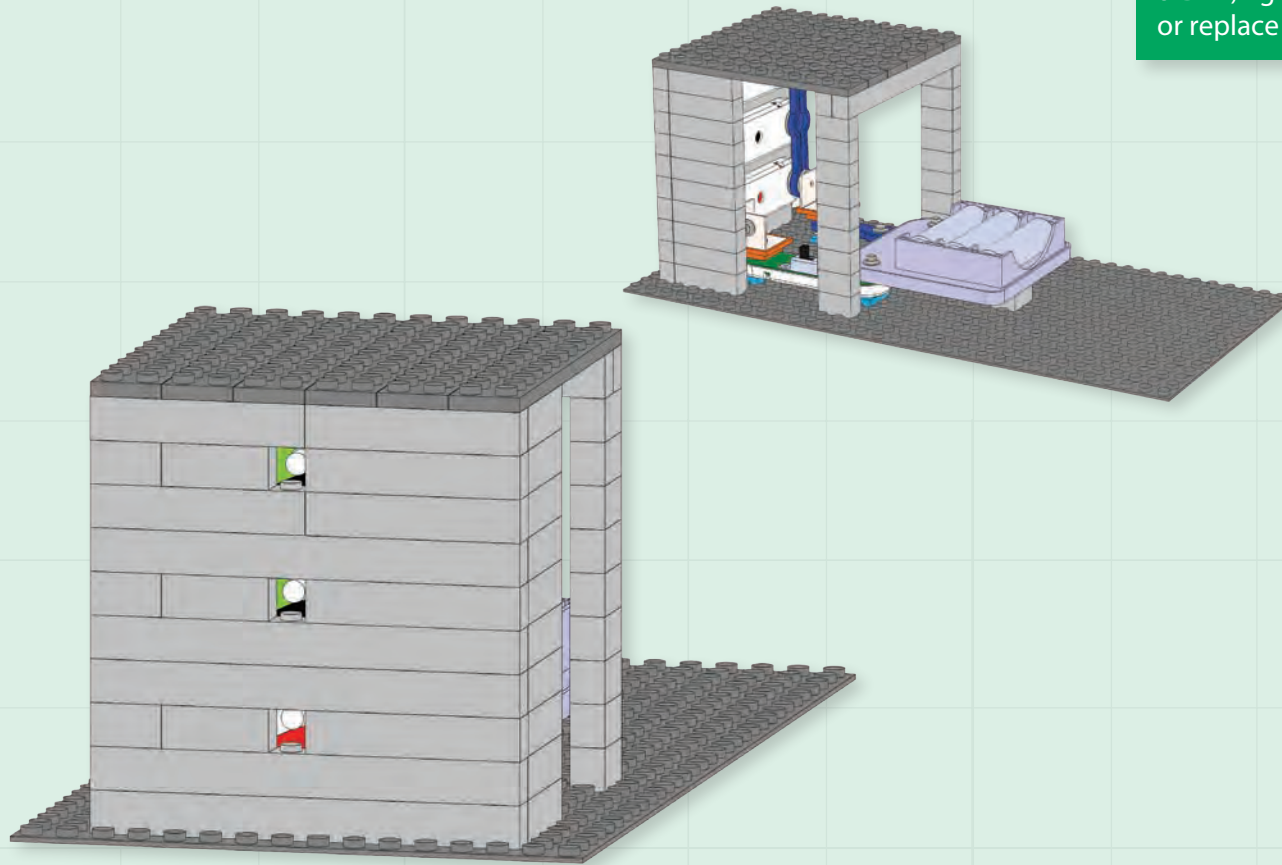



# Project 18

# LIGHT HOUSE

1

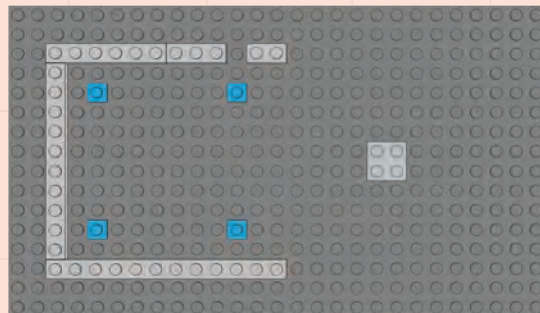
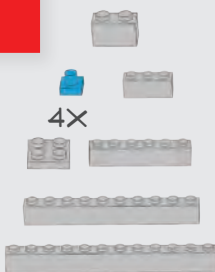

2

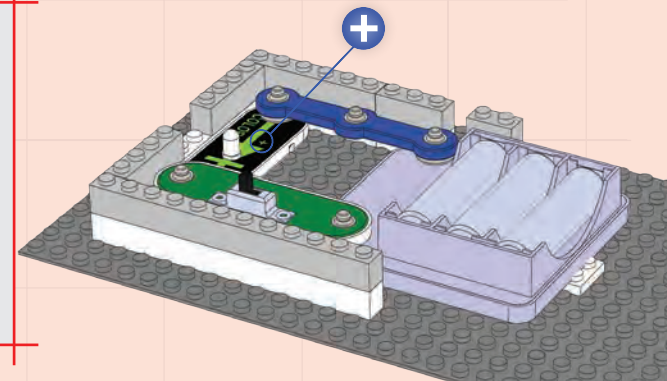
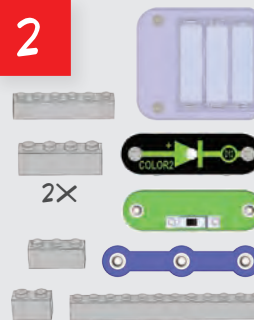

3

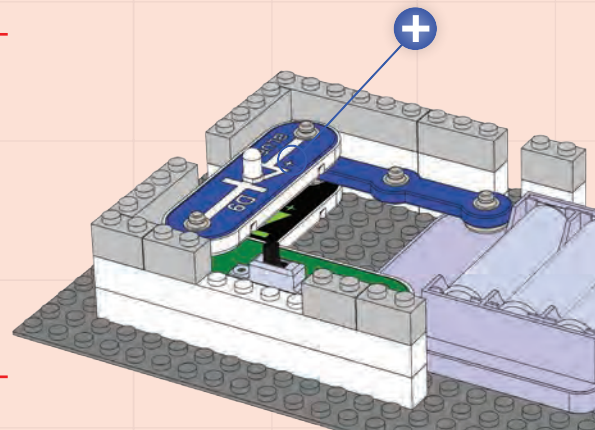
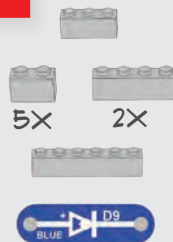

4

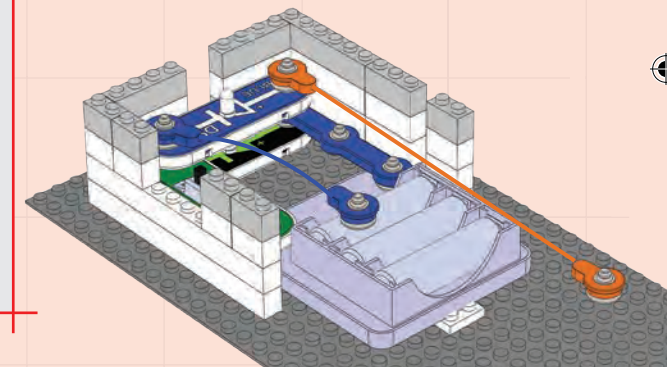
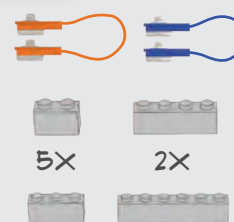

5

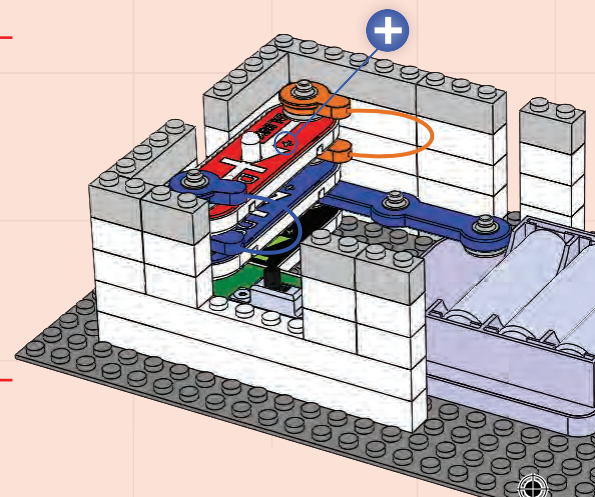
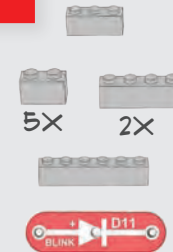

6

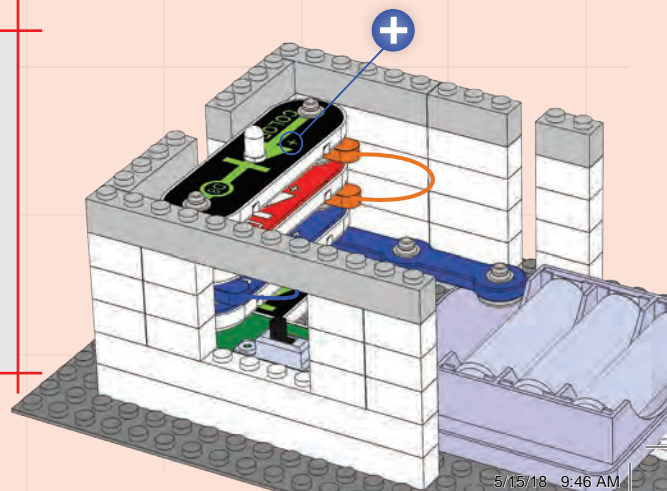

# Project 18

# LIGHT HOUSE

Build the circuit as shown, and turn on the slide switch (S1). The blue and color2 LEDs (D9 & D12) light. You can replace the LEDs with any of the other lights.

**7**

2X  
3X

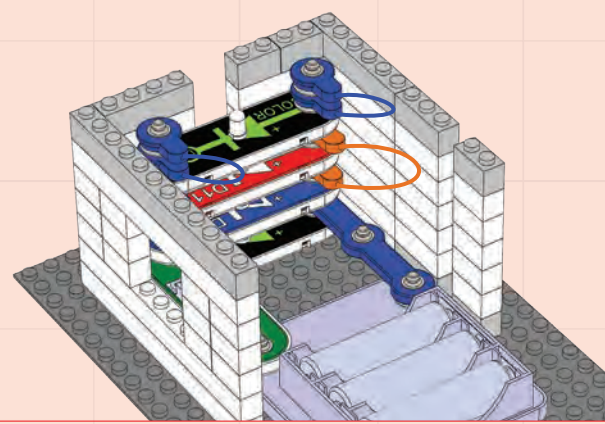

**8**

1X  
1X  
1X  
1X

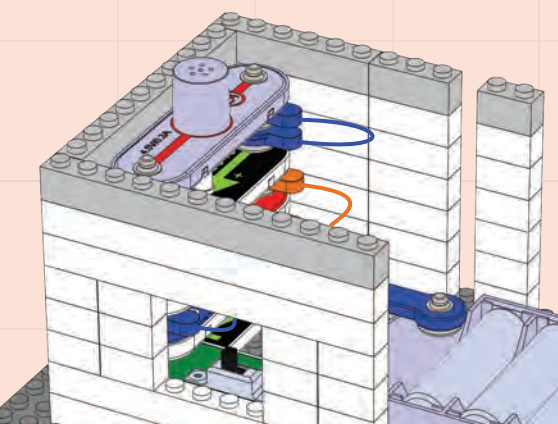

**9**

5X

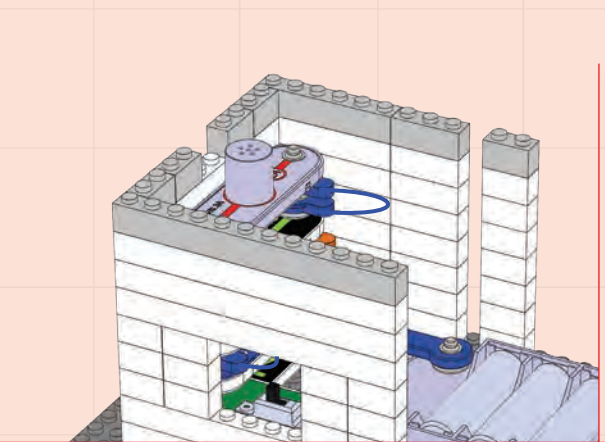

**10**

1X  
1X  
1X

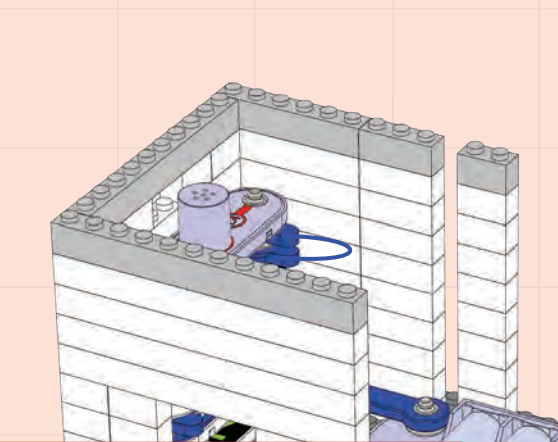

**11**

6X

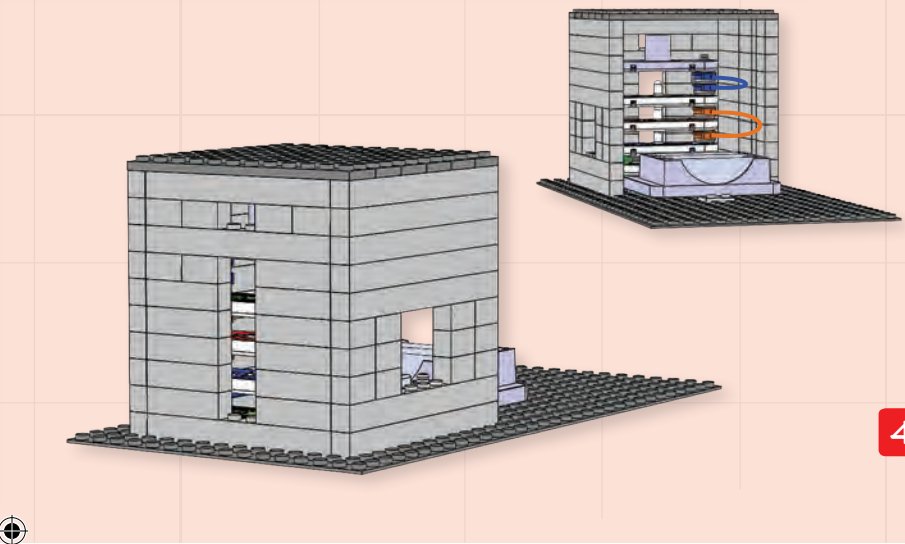
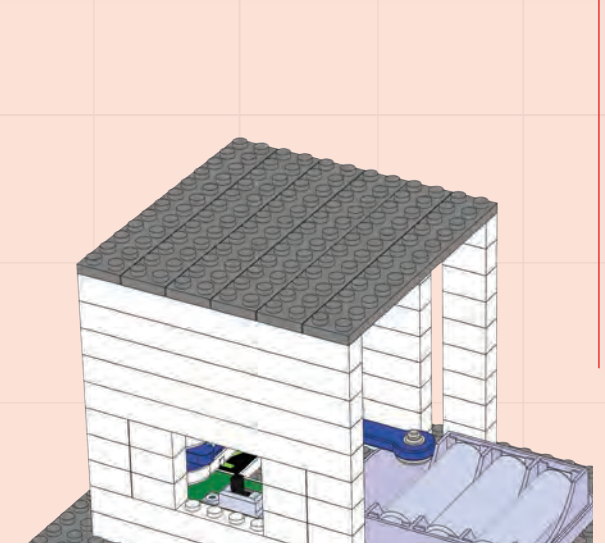





# Project 19

# FOUR FUN

1

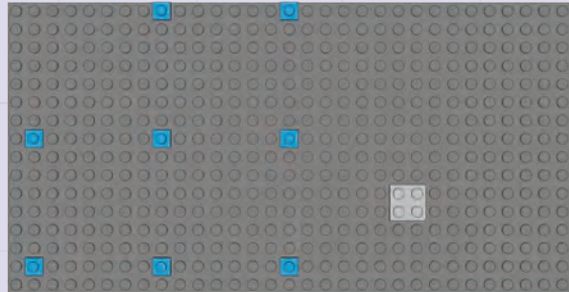
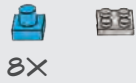

2

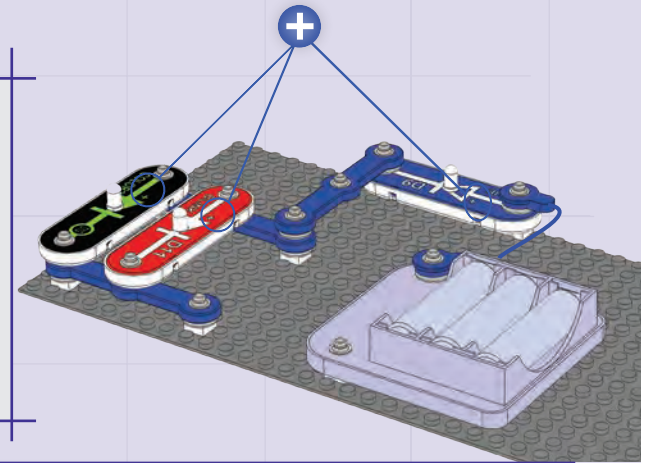
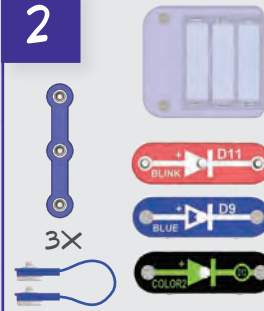

3

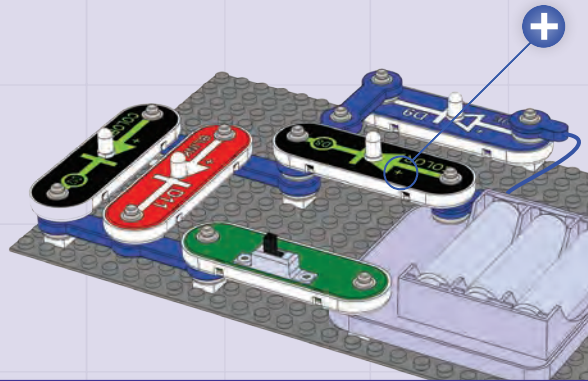

This circuit has two pairs of parallel LEDs in series with each other. Some of the LEDs are blinking in different patterns (D11 turning on and off, D8 changing colors quickly, and D12 changing colors slowly). Red color is easier to produce than green or blue, and green is easier to produce than blue. The combination of these effects creates the pattern you see.



Build the circuit as shown, and turn on the slide switch (S1). The four LEDs light in a blinking pattern, but some will be dim. You can swap the LEDs with each other and see how the circuit changes. You can also remove one LED, or replace one with the melody IC (U32).

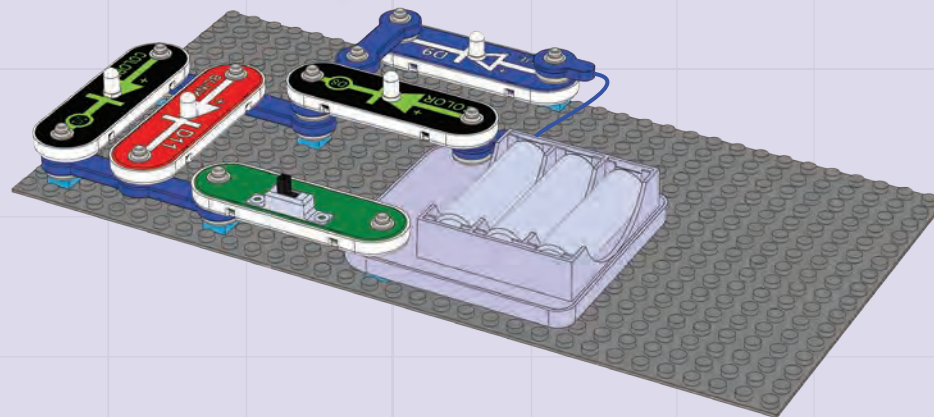



# Project 20 FOUR FURTHER FUN

1

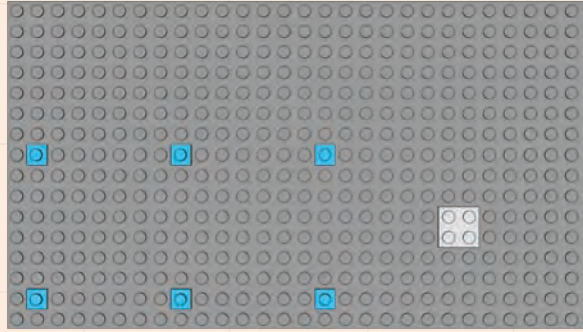
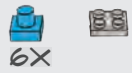

2

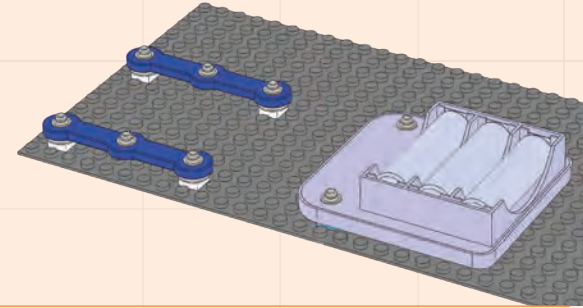

3

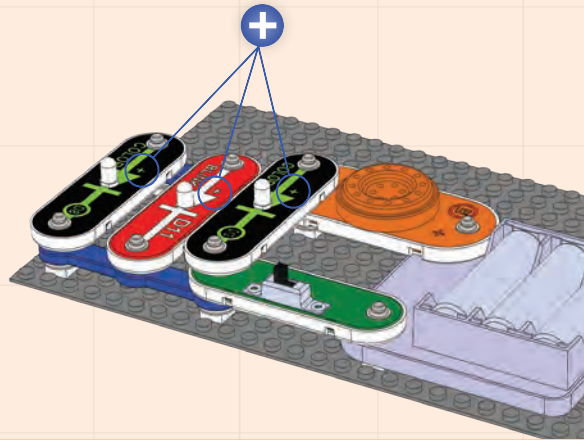

Build the circuit as shown, and turn on the slide switch (S1). The three LEDs (D8, D11, & D12) light in a dim blinking pattern, and the melody IC (U32) makes weird sounds. Try removing one of the LEDs at a time and see how the sound changes.



Electricity from the batteries goes through the melody IC, then splits up and goes through the three LEDs, then re-combines in the switch. The LEDs all having different blinking patterns and the melody IC has a sound pattern; their combination creates the effects you see and hear.

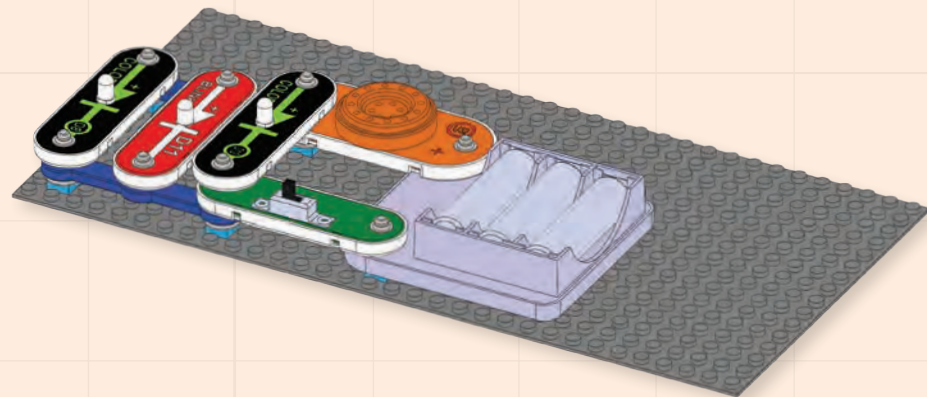

# Project 21

# BRIC ELEVATION

1

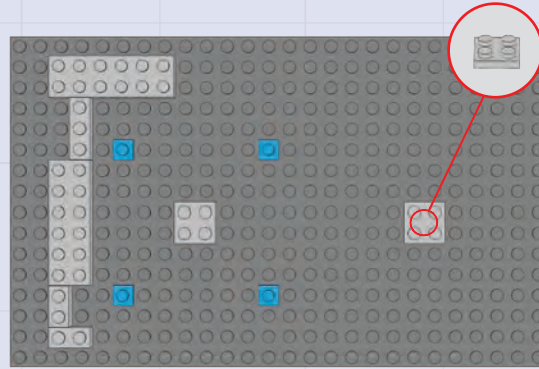

2

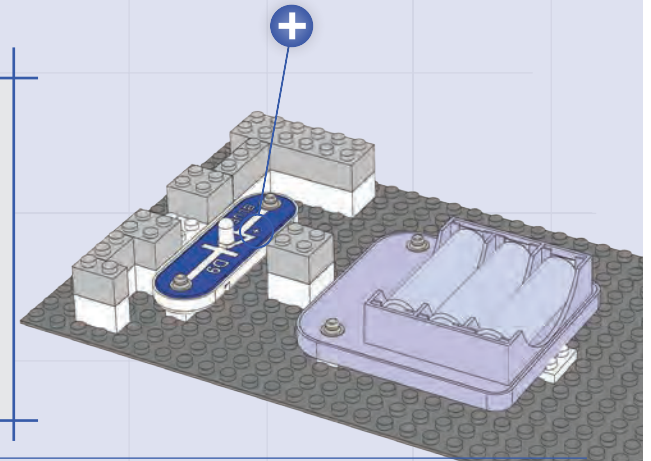
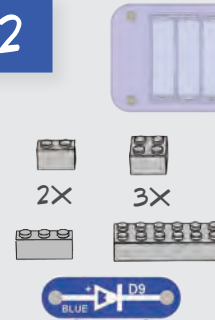

3

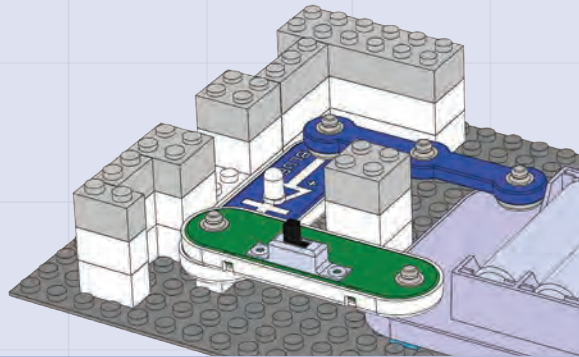

4

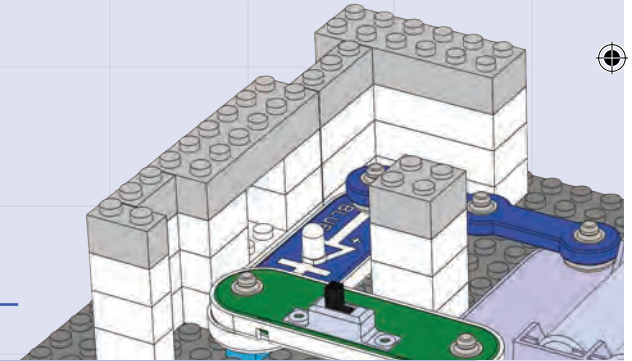
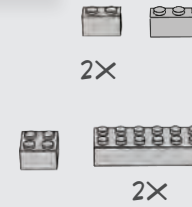

5

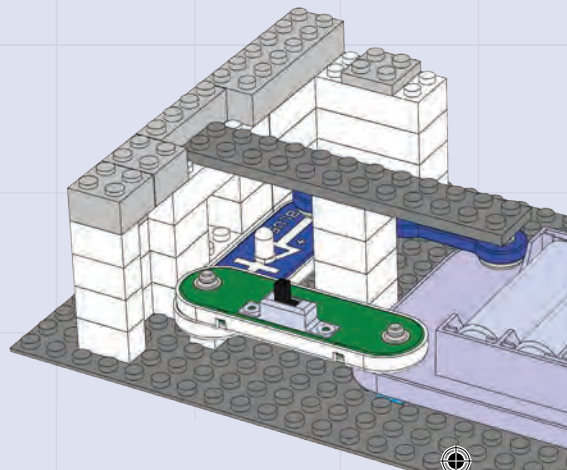
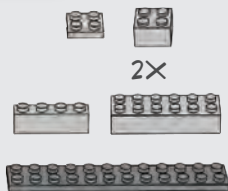

6

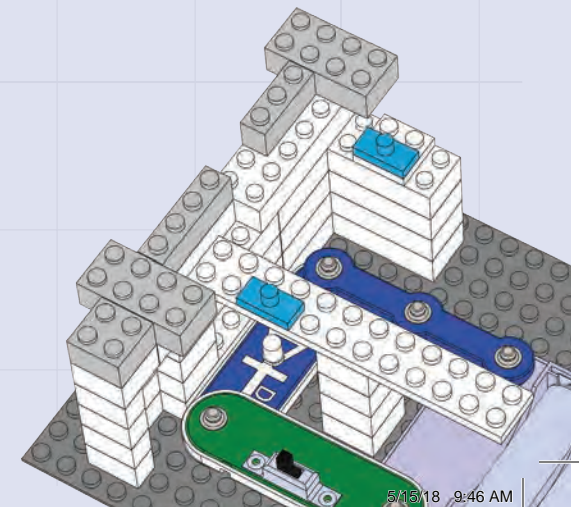
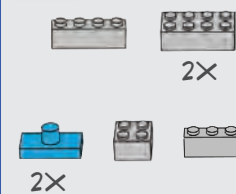





# Project 21

# BRIC ELEVATION

Build the circuit as shown, and turn on the slide switch (S1). The blue and color2 LEDs (D9 & D12) light. You can replace the LEDs with any of the other lights.

7

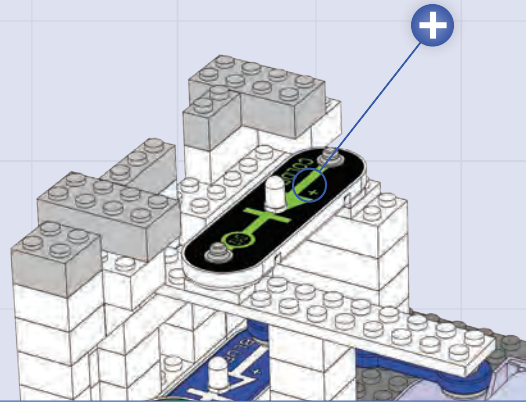

8

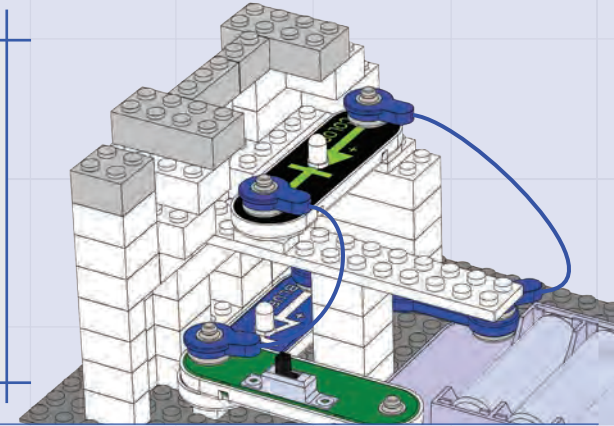
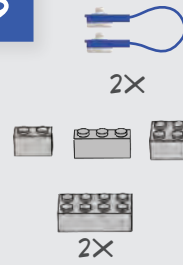

9

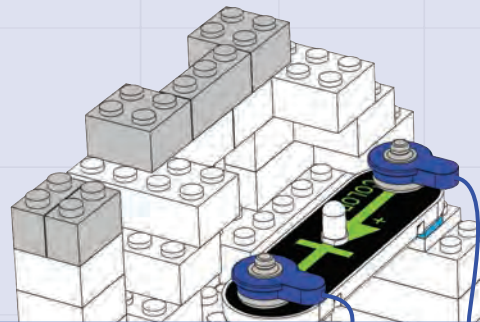

10

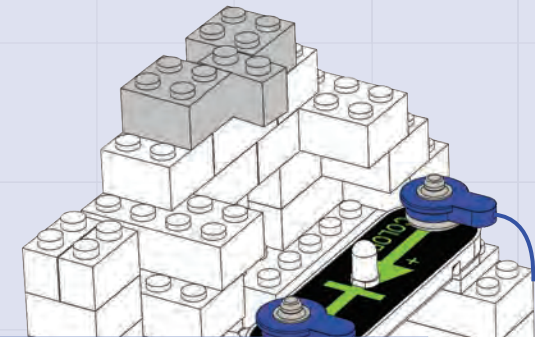

11

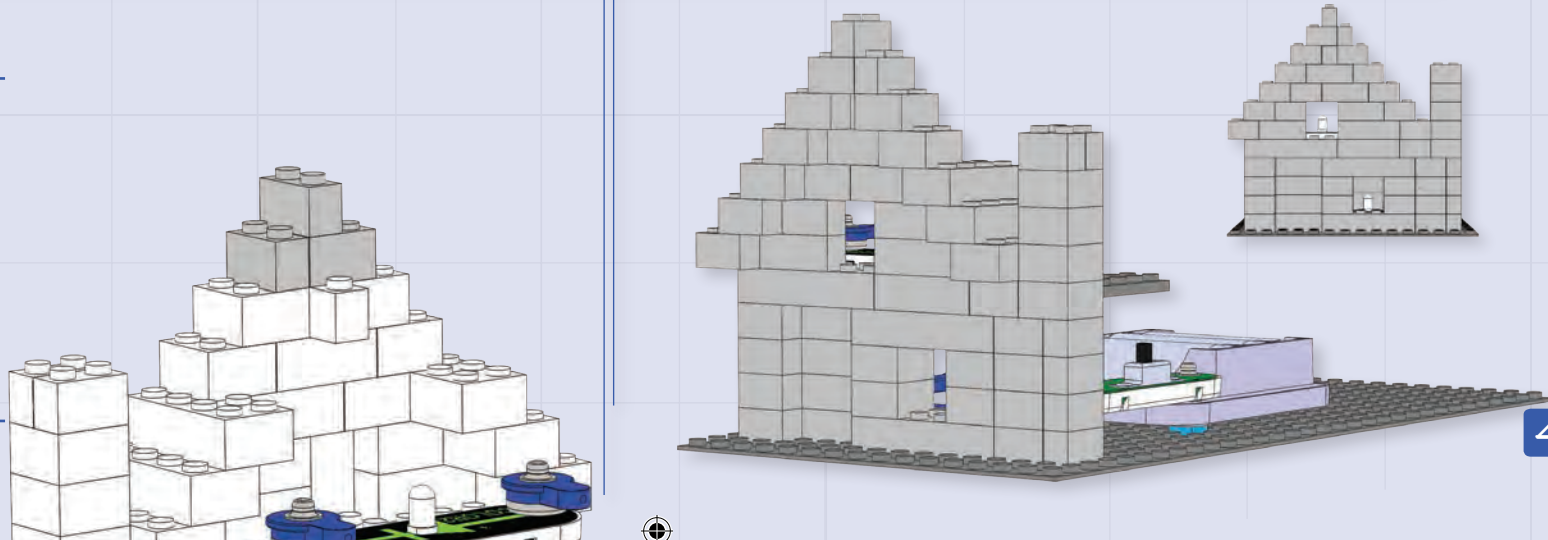

# Project 22

# BRIC HOUSE

**1**

- 2x [1x5 grey Technic brick]
- 3x [1x3 grey Technic brick]
- 4x [1x2 grey Technic brick]
- 6x [1x1 blue Technic pin]
- 9x [1x1 grey Technic pin]

**2**

- 1x [1x3 purple battery holder]
- 1x [1x3 blue Technic pin]
- 1x [1x3 blue Technic pin with D9 label]
- 1x [1x3 green battery]
- 2x [Orange jumper wires]

**3**

- 1x [1x3 black LED with green arrow]
- 3x [1x2 grey Technic brick]
- 2x [1x3 grey Technic brick]
- 2x [1x2 grey Technic brick]

**4**

- 3x [1x5 grey Technic brick]
- 2x [1x3 grey Technic brick]
- 4x [1x2 grey Technic brick]
- 6x [1x1 grey Technic pin]
- 2x [1x2 grey Technic brick]

**5**

- 2x [1x2 blue Technic pin]
- 2x [1x2 grey Technic pin]
- 3x [1x3 grey Technic brick]

**6**

- 2x [1x3 black LED with green arrow]
- 1x [1x3 blue Technic pin]





# Project 22 BRIC HOUSE

7

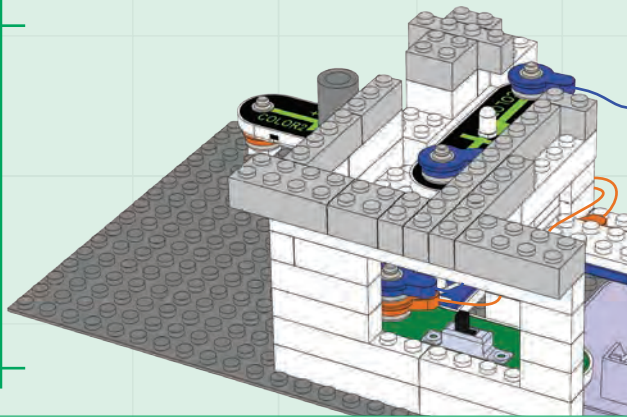
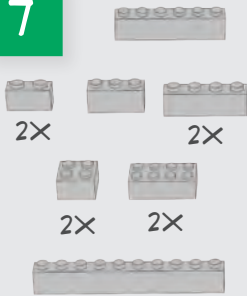

8

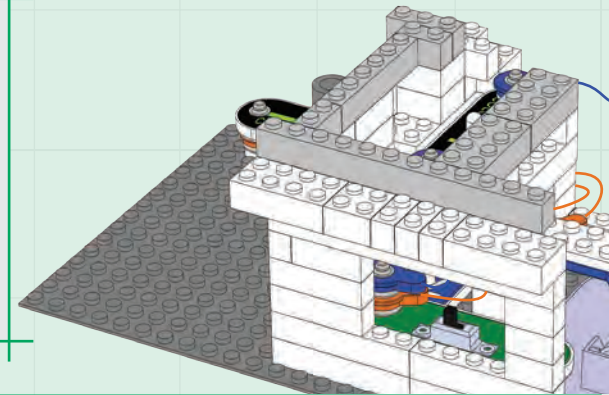
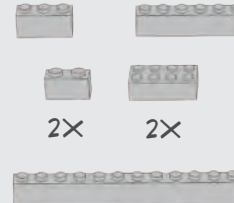

9

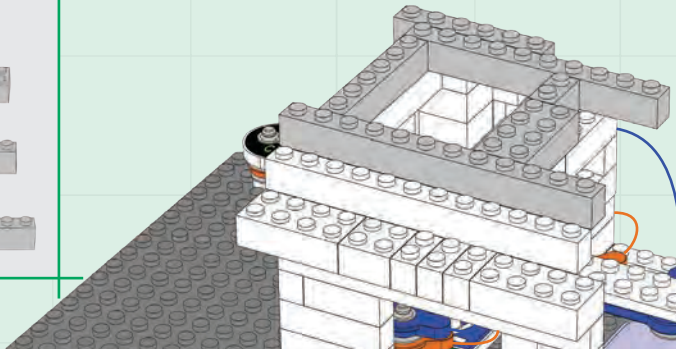
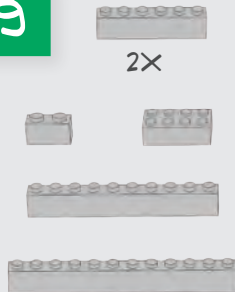

10

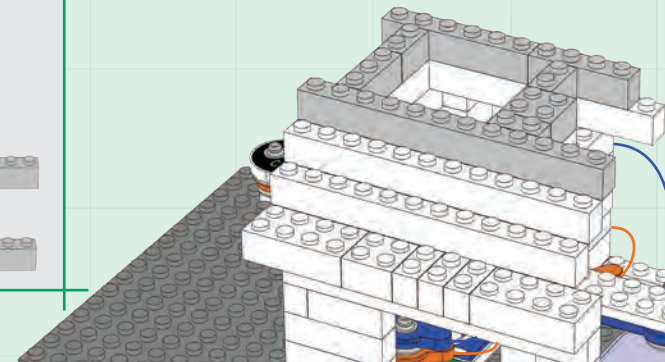
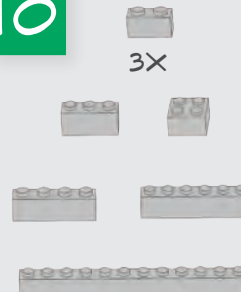

11

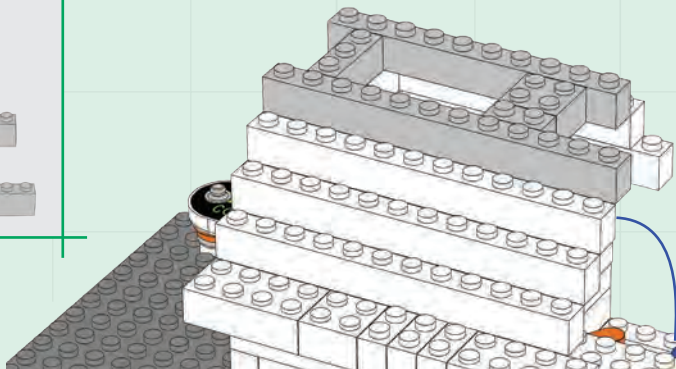
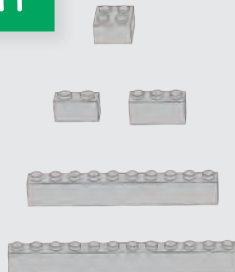

12

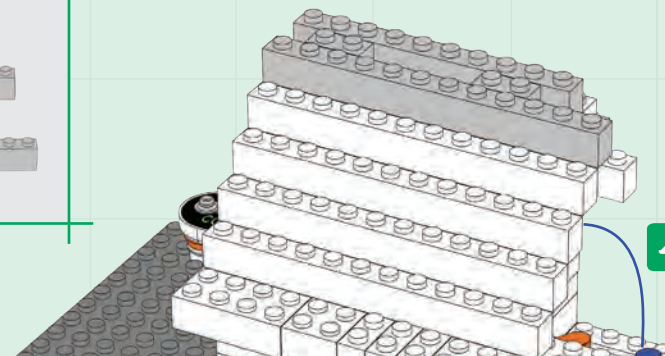
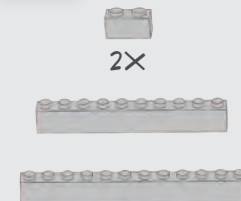



# Project 22 *BRIC HOUSE*

13

- 4x
- 5x
- 
- 6x

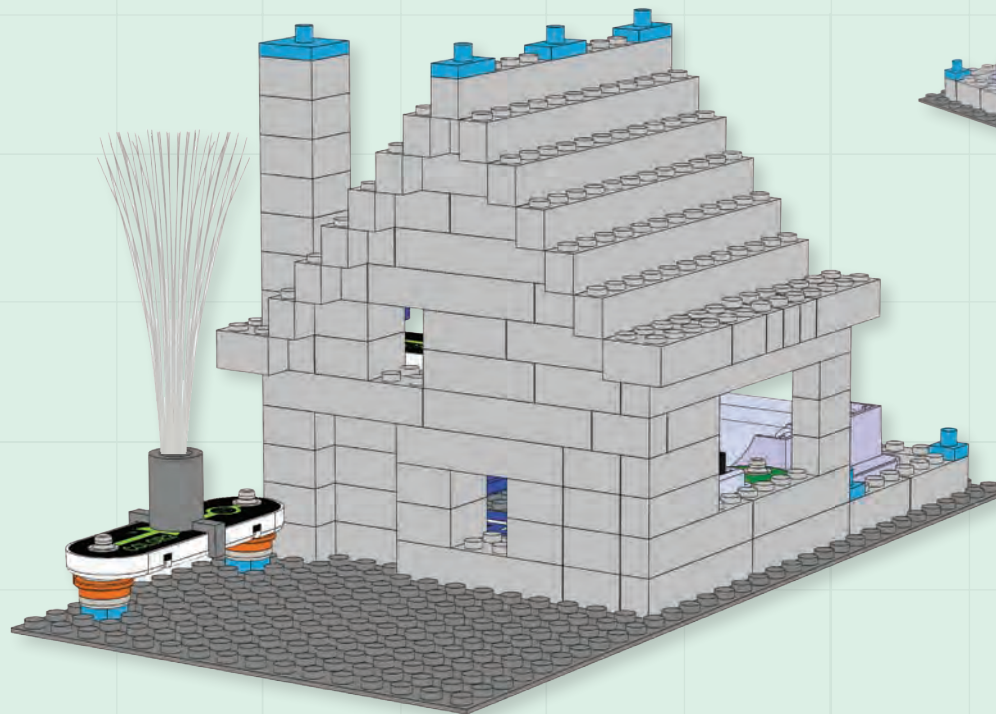
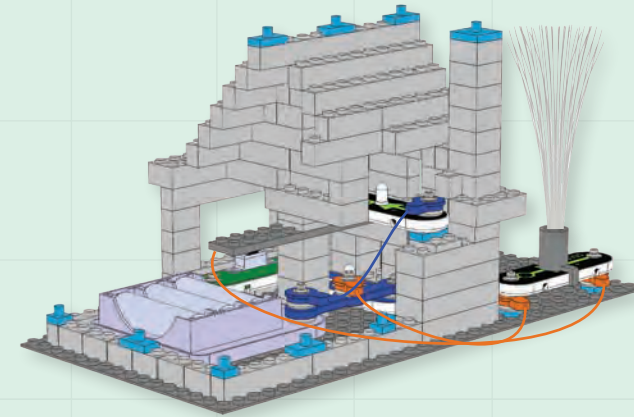
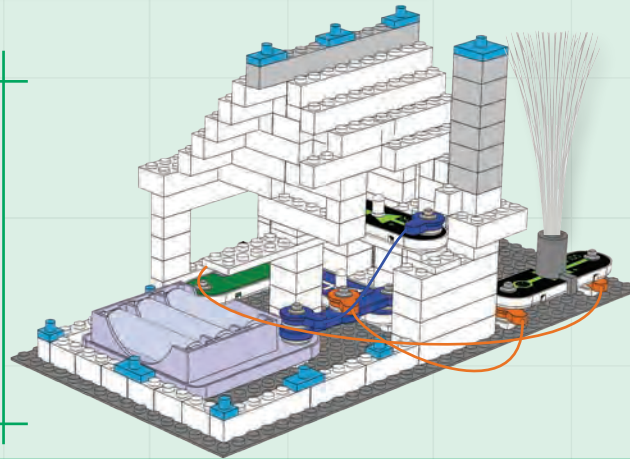



# Project 23 *DIAGONAL CIRCUIT*

1

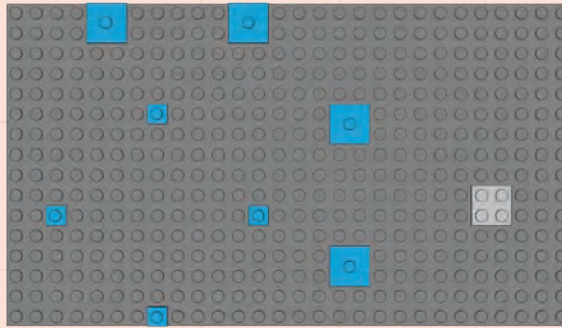

2

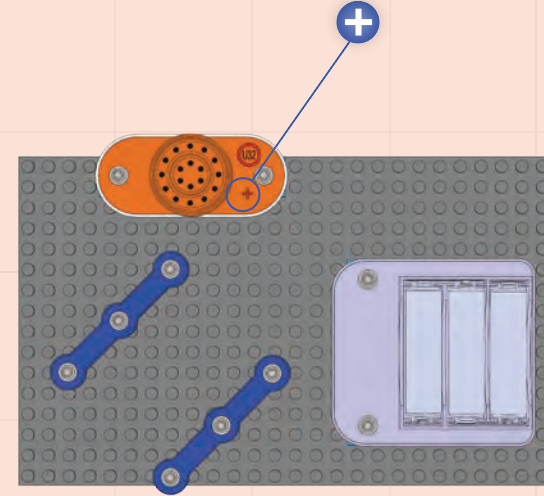

3

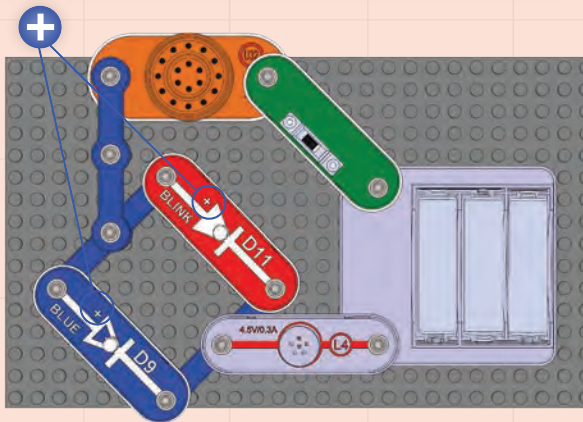

4

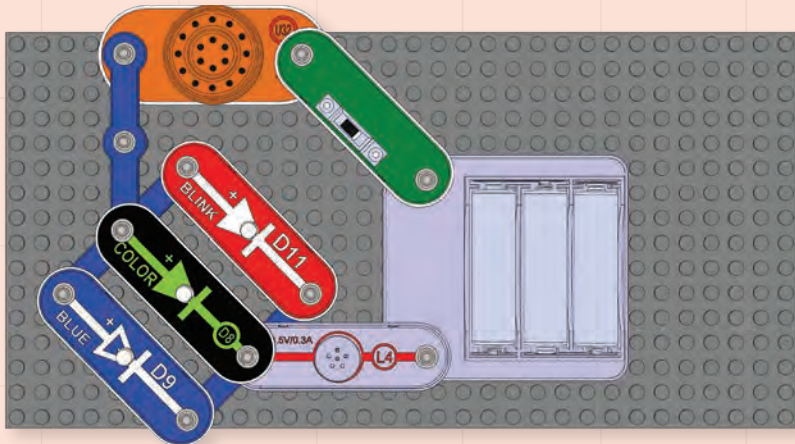
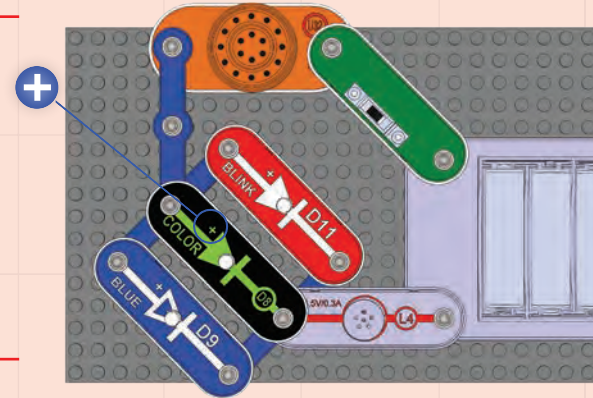

Build the circuit as shown, and turn on the slide switch (S1). The three LEDs (D8, D9, & D11) light in a dim blinking pattern, and the melody IC (U32) makes weird sounds. The lamp (L4) is used here as a 3-snap wire and does not light. Try replacing one of the LEDs with the color2 LED (D12).

# Project 24 WALL OF LIGHT

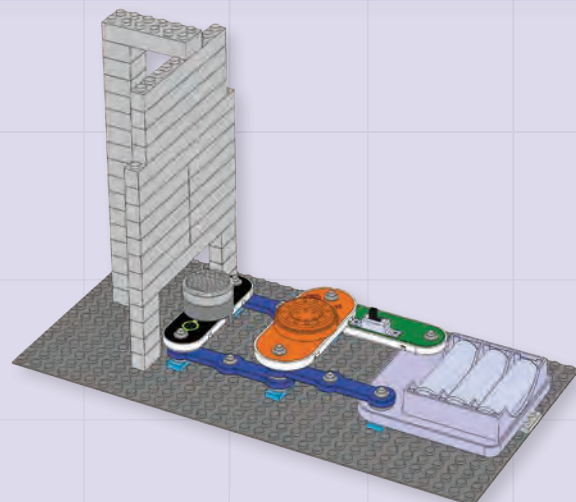
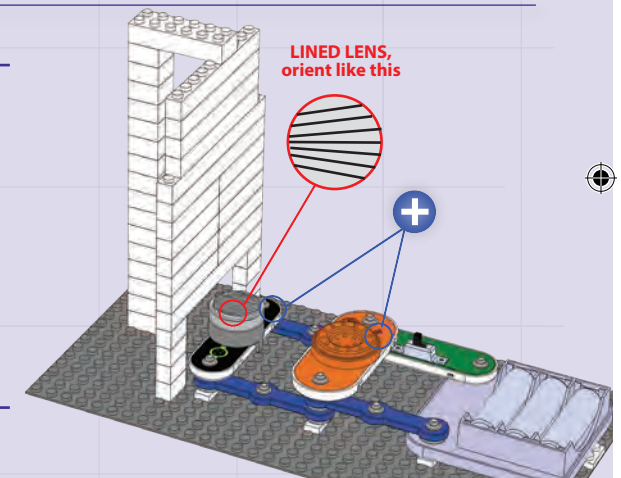
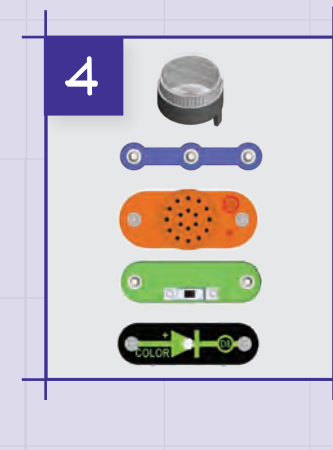
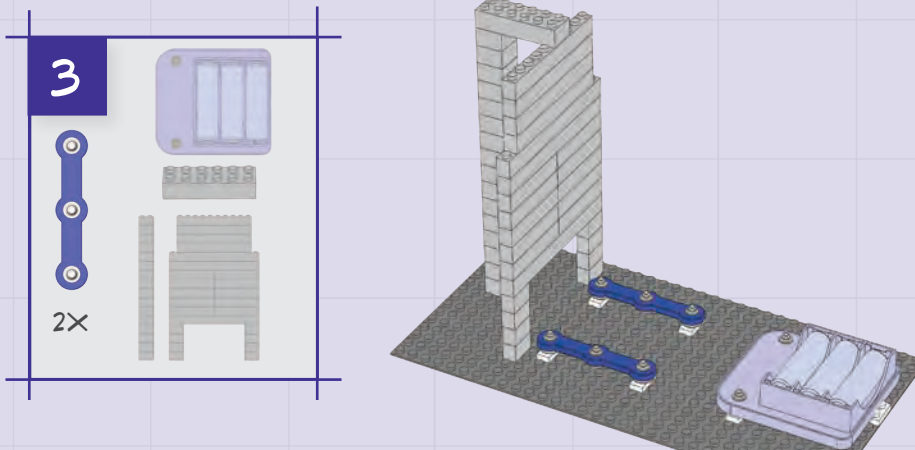
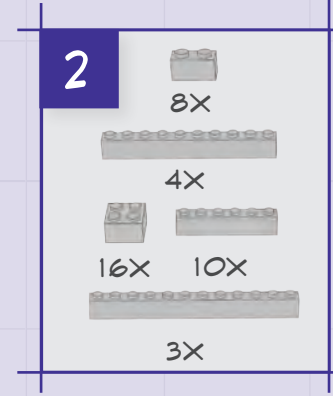
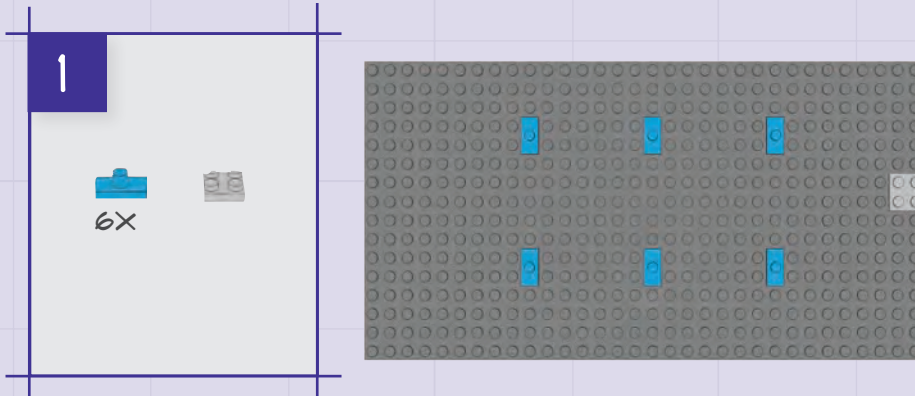

Build the circuit as shown, and turn on the slide switch (S1). The color LED (D8) shines a colorful pattern on the wall of bricks, for best effects rotate the lined lens so its lines converge toward the wall, and place the circuit in a dark room. The melody IC (U32) makes sound, and can be removed from the circuit if desired. You can replace the color LED (D8) with the color2 LED (D12) to change the effects.



# Project 25 YOUR WALL OF LIGHT

1

4X

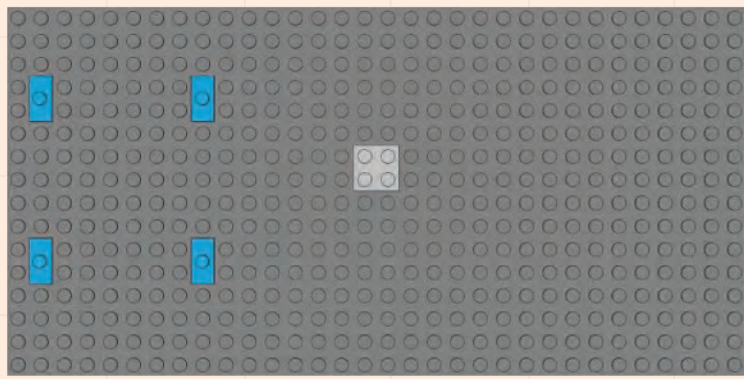

2



Place this circuit close to a wall in a dark room. For best effects rotate the lined lens so its lines converge toward the wall. You can replace the color LED (D8) with the color2 LED (D12) to change the effects.

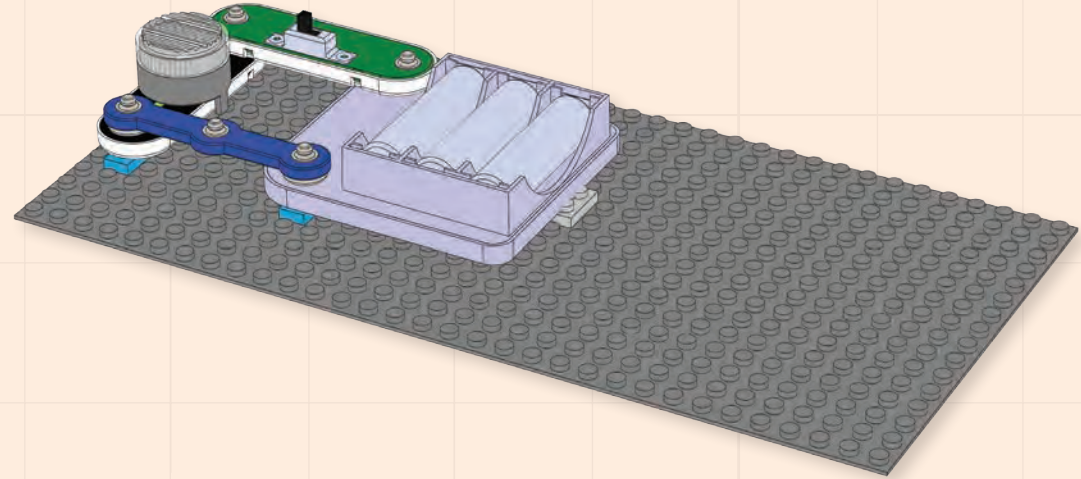
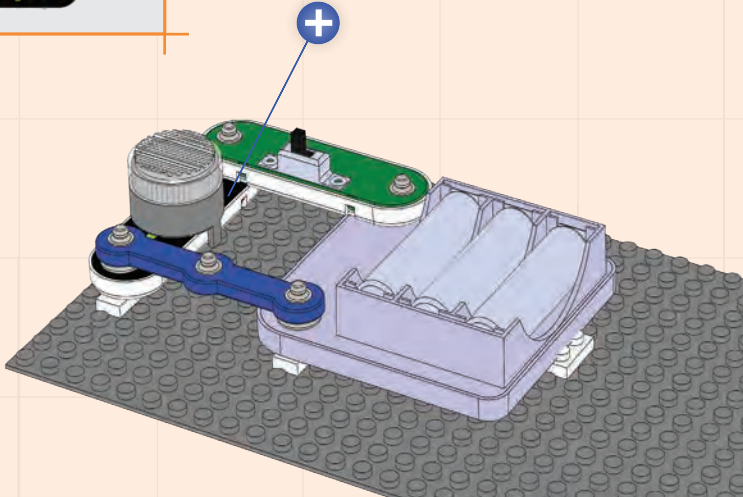

# Project 26 2 STORY HOUSE

- 1**
- 4x 4x
  - 4x 4x
  - 2x 2x
  - 5x 5x
  - 2x 2x
  - 2x 2x

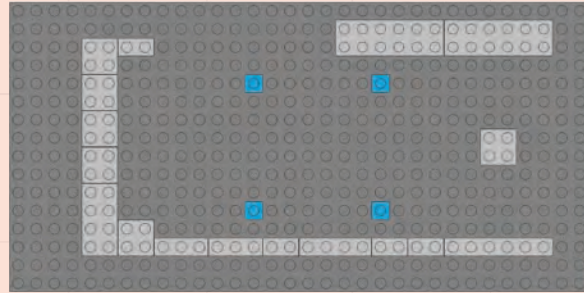

- 2**
- 1x 1x
  - 1x 1x
  - 1x 1x
  - 4x 4x
  - 4x 4x
  - 4x 4x
  - 4x 4x

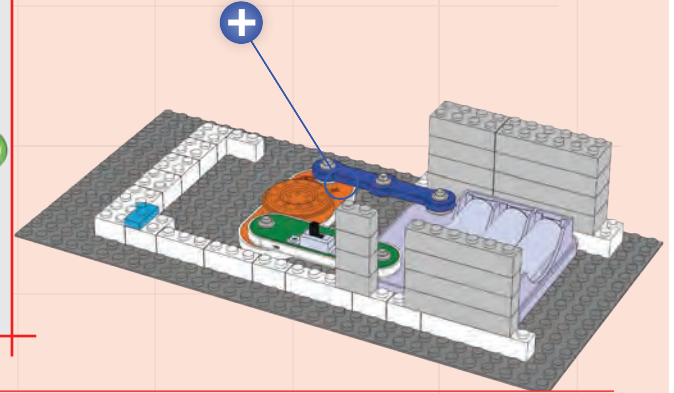

- 3**
- 1x 1x
  - 2x 2x
  - 2x 2x
  - 1x 1x

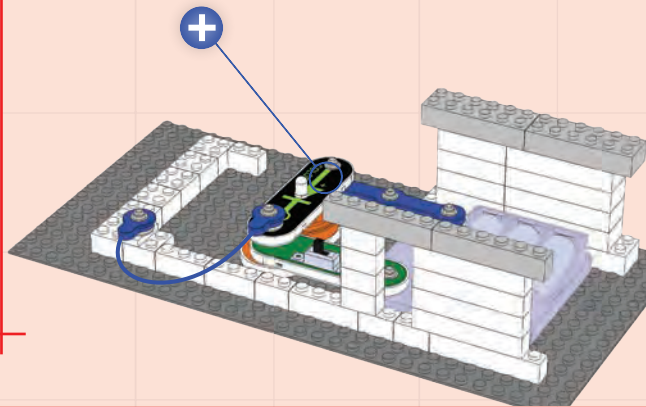

- 4**
- 2x 2x
  - 8x 8x
  - 6x 6x

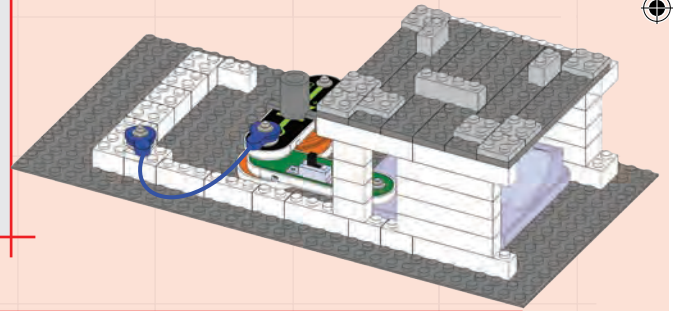

- 5**
- 6x 6x
  - 4x 4x
  - 3x 3x

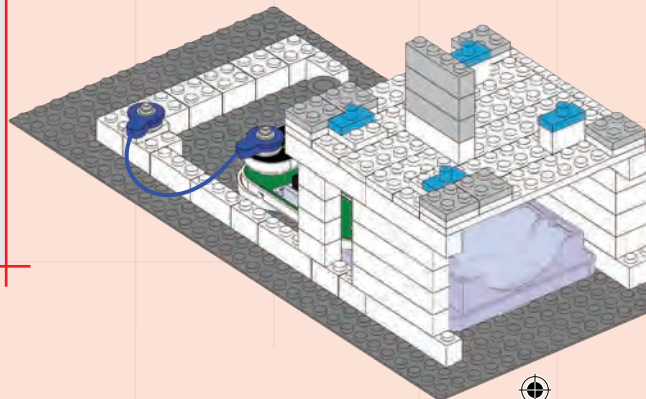

- 6**
- 2x 2x
  - 2x 2x
  - 2x 2x
  - 1x 1x

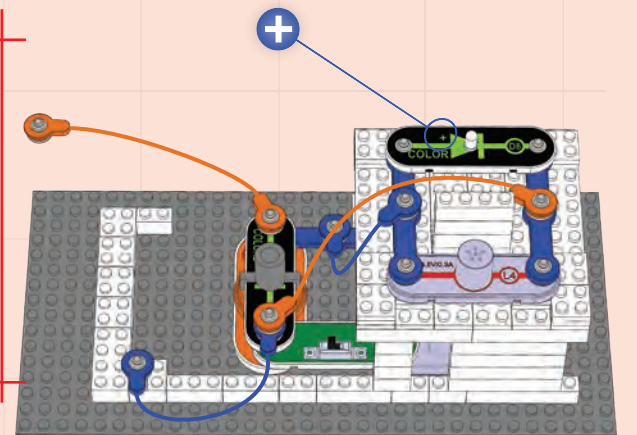



# Project 26 2 STORY HOUSE

7

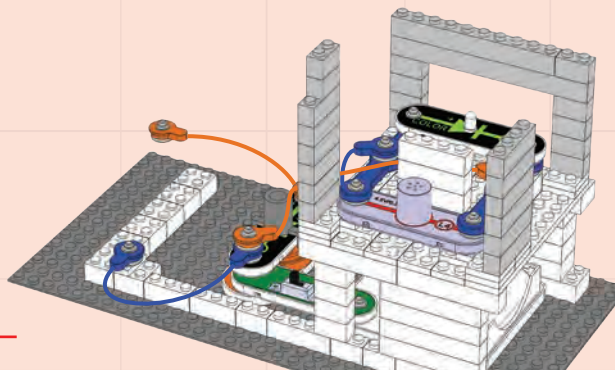
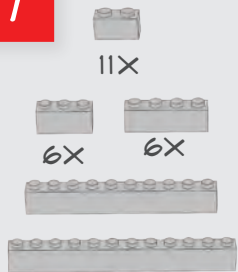

8

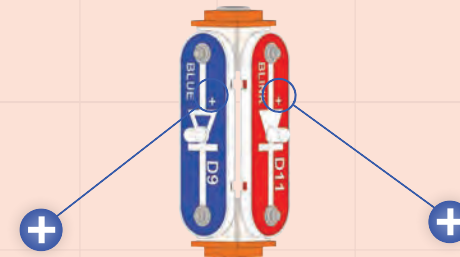

9

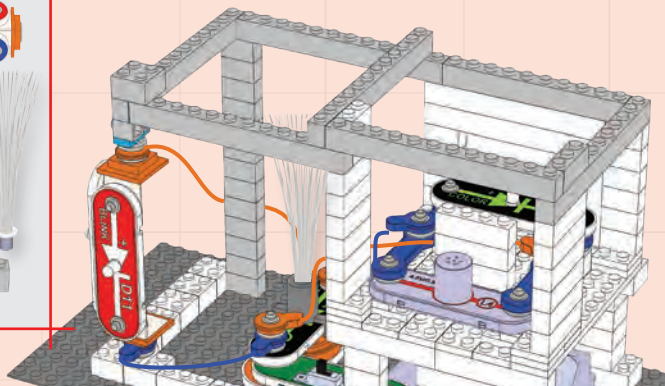

10

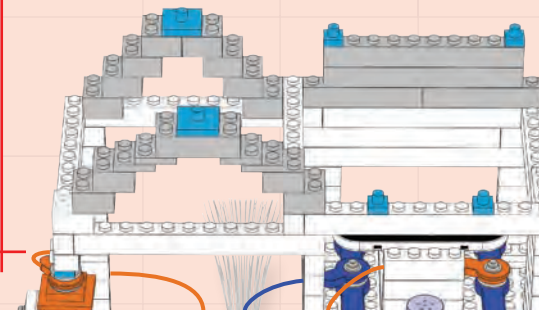

This structure is shown on the cover of your box, use that picture as a guide in building it.



Project 26

2 STORY HOUSE

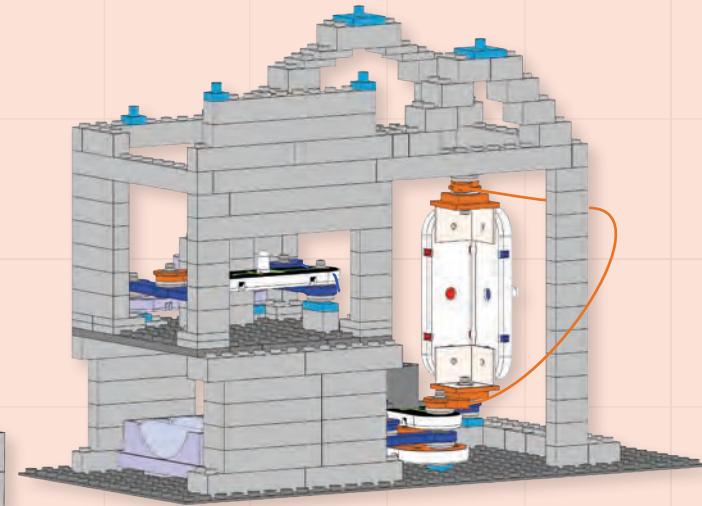
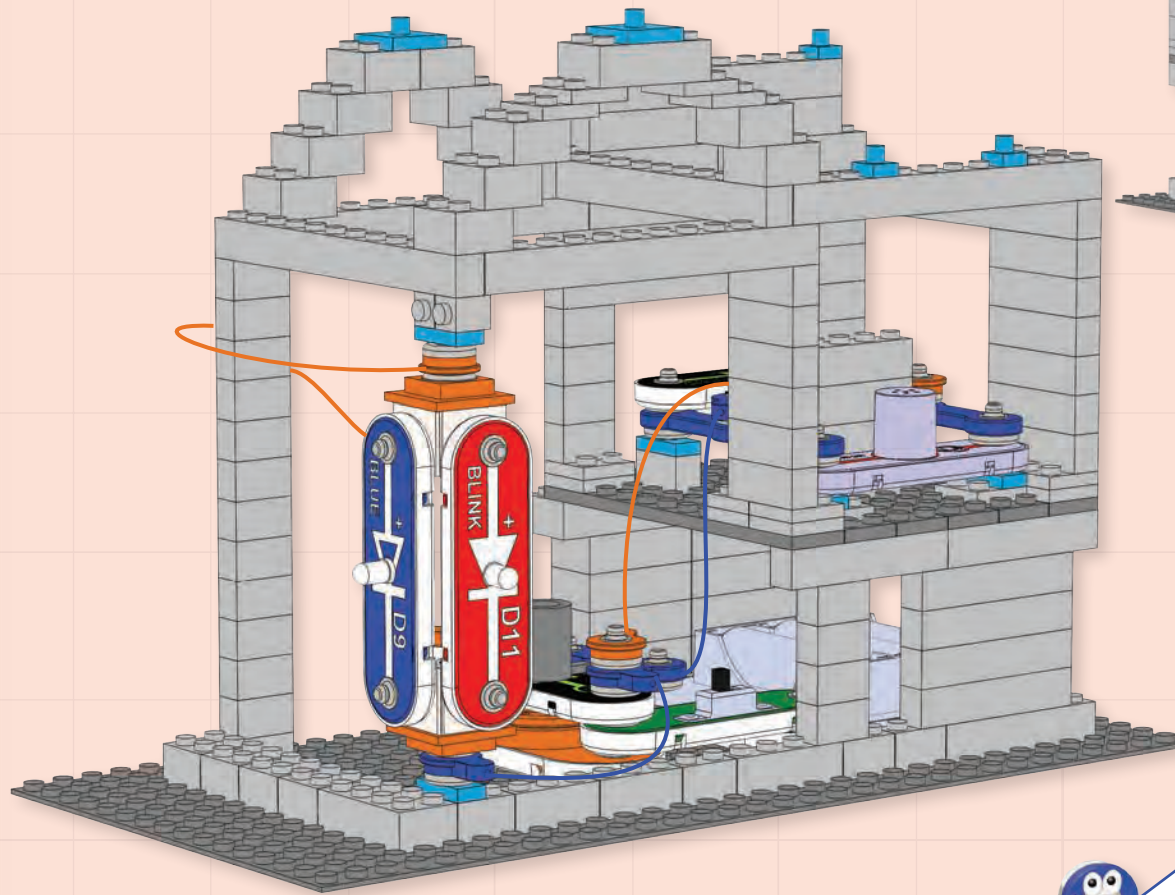

**What's next?** Your set includes more brick-to-snap adapters than are needed to build the structures in this book, so that you may expand on your own using parts from other Boffin and bricks sets you may have.





NOTES:





NOTES:





# Other Boffin Products!

For a listing of local toy retailers who carry Boffin visit **boffin.cz** or call us toll-free at +420 284 000 111

For Boffin accessories or additional parts visit **boffin.cz**.

## BOFFIN BEGINNER

Model SCB-20

Begin your Boffin Experience with a wonderful introduction to problem solving, following directions and the satisfaction of a job well done.

- Includes 14 parts build over 20 projects.
- Extra safety features for younger engineers, 5 and up.
- Easy-to-follow color manual diagrammed like no other Boffin Kit.

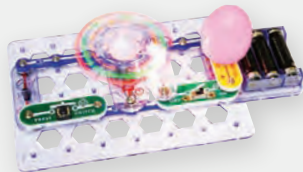

## SNAPINO

Model SC-SNAPINO

Snapino is an introduction to the open source Arduino® Hardware software environment. Learn to code and utilize your Boffin modules at the same time!

- A great introduction to coding and the Arduino platform
- Arduino is a microcontroller used in robotics and other applications
- Includes over 15 parts build over 20 projects.



## BOFFIN 3D MEG

Model SC-3DMEG

Boffin 3D-MEG uses building pieces with snaps to make realistic, 3-D circuits, like those found in homes, electronic equipment and skyscrapers. Boffin Kids can build their own house with roof lights and ceiling fans while finding out how all the electric and mechanical functions work!

- Contains unique "stabilizers" for building amazing 3D structures. Kids love making their circuit inventions into 3D!



## BOFFIN 3D ILLUMINATION

Model SC-3Di

Boffin 3D Illumination uses building blocks with snaps to build the different electrical and electronic circuits in the projects. Each block has a function: there are switch blocks, light blocks, battery blocks, different length wire blocks, etc.

- 3-Color Light Tunnel, Mirrors & Reflecting Circuits
- Projector With 6 Images



## BOFFIN ARCADE

Model SCA-200

Boffin Arcade is an exciting introduction to problem solving, following directions and the satisfaction of a job well done.

- 30 Snap Modules included
- More than 200 projects
- Enjoy completing projects using a programmable Word Fan, Dual LED Display and a pre-programmed microcontroller.

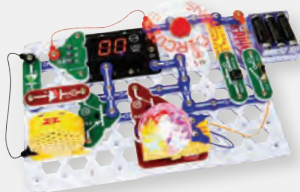

## BOFFIN LIGHT

Model SCL-175

- Contains over 55 parts. Build over 175 exciting projects.
- Color organ controlled by smart-phone, voice or finger.
- Enjoy your music as the lights change to the beat.
- Snap-together parts require no tools and ensure correct connections.
- Clear and concise illustrated manual included & available online



Smart-phone shown not included.

## BOFFIN JR

Model SC-100

- Over 30 parts and over 100 projects



## BOFFIN

Model SC-300

- Over 60 parts and over 300 projects



## BOFFIN MOTION

Model SCM-165

- Over 50 parts and over 165 projects



## BOFFIN EXTREME

Model SC-750

- Over 80 parts and over 750 projects





# SC-BRIC1 Parts Layout

Note: A complete list is on pages 2 in this manual.

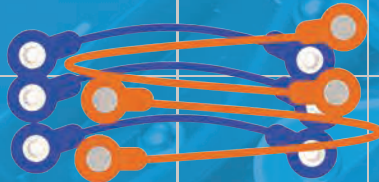
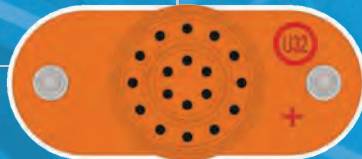
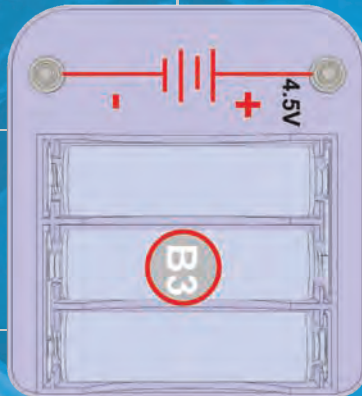

25X 1X1  
BRIC-2-SNAP



25X 1X2  
BRIC-2-SNAP



25X 2X2  
BRIC-2-SNAP



20X



6X



33X



11X



11X



18X



6X



8X



10X



4X



4X

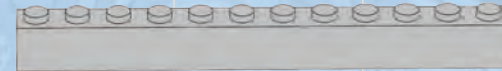

7X

NOTE: NOT PICTURED 10" X 5" BASE PLATE

ConQuest entertainment a.s. is not responsible for typographical errors.

**Important: If parts are missing or damaged,  
DO NOT RETURN TO RETAILER.**  
Call + 420 284 000 111 or e-mail: [info@cqe.cz](mailto:info@cqe.cz).